



Obsolete Device

# 27LV256

## 256K (32K x 8) Low-Voltage CMOS EPROM

### FEATURES

- Wide voltage range 3.0V to 5.5V
- High speed performance
  - 200 ns access time available at 3.0V
- CMOS Technology for low power consumption
  - 8 mA Active current at 3.0V
  - 20 mA Active current at 5.5V
  - 100  $\mu$ A Standby current
- Factory programming available
- Auto-insertion-compatible plastic packages
- Auto ID aids automated programming
- Separate chip enable and output enable controls
- High speed "Express" programming algorithm
- Organized 32K x 8: JEDEC standard pinouts
  - 28-pin Dual-in-line package
  - 32-pin PLCC package
  - 28-pin SOIC package
  - Tape and reel
- Data Retention > 200 years
- Available for the following temperature ranges:
  - Commercial: 0°C to +70°C
  - Industrial: -40°C to +85°C

### DESCRIPTION

The Microchip Technology Inc. 27LV256 is a low voltage (3.0 volt) CMOS EPROM designed for battery powered applications. The device is organized as a 32K x 8 (32K-Byte) non-volatile memory product. The 27LV256 consumes only 8 mA maximum of active current during a 3.0 volt read operation therefore improving battery performance. This device is designed for very low voltage applications where conventional 5.0 volt only EPROMS can not be used. Accessing individual bytes from an address transition or from power-up (chip enable pin going low) is accomplished in less than 200 ns at 3.0V. This device allows systems designers the ability to use low voltage non-volatile memory with today's low voltage microprocessors and peripherals in battery powered applications.

A complete family of packages is offered to provide the most flexibility in applications. For surface mount applications, PLCC or SOIC packaging is available. Tape and reel packaging is also available for PLCC or SOIC packages.

### PACKAGE TYPES

#### PDIP

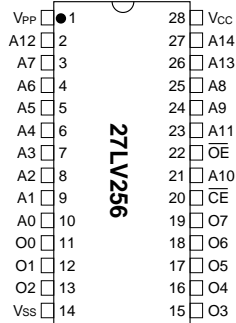

#### PLCC

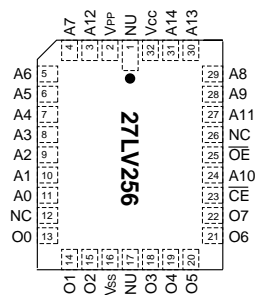

#### SOIC

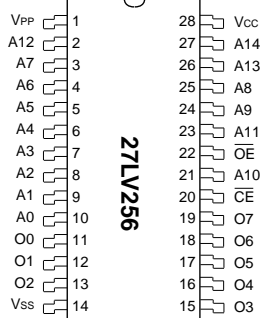

# 27LV256

## 1.0 ELECTRICAL CHARACTERISTICS

### 1.1 Maximum Ratings\*

VCC and input voltages w.r.t. VSS ..... -0.6V to +7.25V

VPP voltage w.r.t. VSS during programming ..... -0.6V to +14V

Voltage on A9 w.r.t. VSS ..... -0.6V to +13.5V

Output voltage w.r.t. VSS ..... -0.6V to VCC +1.0V

Storage temperature ..... -65°C to +150°C

Ambient temp. with power applied ..... -65°C to +125°C

\*Notice: Stresses above those listed under "Maximum Ratings" may cause permanent damage to the device. This is a stress rating only and functional operation of the device at those or any other conditions above those indicated in the operation listings of this specification is not implied. Exposure to maximum rating conditions for extended periods may affect device reliability.

TABLE 1-1: PIN FUNCTION TABLE

Name	Function
A0-A14	Address Inputs
$\overline{CE}$	Chip Enable
$\overline{OE}$	Output Enable
VPP	Programming Voltage
O0 - O7	Data Output
VCC	+5V or +3V Power Supply
VSS	Ground
NC	No Connection; No Internal Connection
NU	Not Used; No External Connection Is Allowed

TABLE 1-2: READ OPERATION DC CHARACTERISTICS

VCC = +5V ±10% or 3.0V where indicated							
Commercial: Tamb = 0°C to +70°C							
Industrial: Tamb = -40°C to +85°C							
Parameter	Part*	Status	Symbol	Min.	Max.	Units	Conditions
Input Voltages	all	Logic "1"	V <sub>IH</sub>	2.0	V <sub>CC</sub> +1	V	
		Logic "0"	V <sub>IL</sub>	-0.5	0.8	V	
Input Leakage	all		I <sub>LI</sub>	-10	10	μA	V <sub>IN</sub> = 0 to V <sub>CC</sub>
Output Voltages	all	Logic "1"	V <sub>OH</sub>	2.4		V	I <sub>OH</sub> = -400 μA I <sub>OL</sub> = 2.1 mA
		Logic "0"	V <sub>OL</sub>		0.45	V	
Output Leakage	all	—	I <sub>LO</sub>	-10	10	μA	V <sub>OUT</sub> = 0V to V <sub>CC</sub>
Input Capacitance	all	—	C <sub>IN</sub>	—	6	pF	V <sub>IN</sub> = 0V; Tamb = 25°C; f = 1 MHz
Output Capacitance	all	—	C <sub>OUT</sub>	—	12	pF	V <sub>OUT</sub> = 0V; Tamb = 25°C; f = 1 MHz
Power Supply Current, Active	C	TTL input	I <sub>CC1</sub>	—	20 @ 5.0V	mA	V <sub>CC</sub> = 5.5V; V <sub>PP</sub> = V <sub>CC</sub> f = 1 MHz; $\overline{OE} = \overline{CE} = V_{IL}$ ; I <sub>OUT</sub> = 0 mA; V <sub>IL</sub> = -0.1 to 0.8V; V <sub>IH</sub> = 2.0 to V <sub>CC</sub> ; Note 1
	I	TTL input	I <sub>CC2</sub>	—	8 @ 3.0V	mA	
					25 @ 5.0V	mA	
					10 @ 3.0V	mA	
Power Supply Current, Standby	C	TTL input	I <sub>CC</sub> (s)	—	1 @ 3.0V	mA	$\overline{CE} = V_{CC} \pm 0.2V$
	I	TTL input			2 @ 3.0V	mA	
	all	CMOS input			100 @ 3.0V	μA	

\* Parts: C=Commercial Temperature Range

I =Industrial Temperature Ranges

Note 1: Typical active current increases .75 mA per MHz up to operating frequency for all temperature ranges.

**TABLE 1-3: READ OPERATION AC CHARACTERISTICS**

AC Testing Waveform: $V_{IH} = 2.4V$ and $V_{IL} = 0.45V$ ; $V_{OH} = 2.0V$ $V_{OL} = 0.8V$ Output Load: 1 TTL Load + 100 pF Input Rise and Fall Times: 10 ns Ambient Temperature: Commercial: $T_{amb} = 0^{\circ}C$ to $+70^{\circ}C$ Industrial: $T_{amb} = -40^{\circ}C$ to $+85^{\circ}C$									
Parameter	Sym	27HC256-20		27HC256-25		27HC256-30		Units	Conditions
		Min	Max	Min	Max	Min	Max		
Address to Output Delay	tACC	—	200	—	250	—	300	ns	$\overline{CE} = \overline{OE} = V_{IL}$
$\overline{CE}$ to Output Delay	tCE	—	200	—	250	—	300	ns	$\overline{OE} = V_{IL}$
$\overline{OE}$ to Output Delay	tOE	—	100	—	125	—	125	ns	$\overline{CE} = V_{IL}$
$\overline{CE}$ or $\overline{OE}$ to O/P High Impedance	tOFF	0	50	0	50	0	50	ns	
Output Hold from Address $\overline{CE}$ or $\overline{OE}$ , whichever goes first	tOH	0	—	0	—	0	—	ns	

**FIGURE 1-1: READ WAVEFORMS**

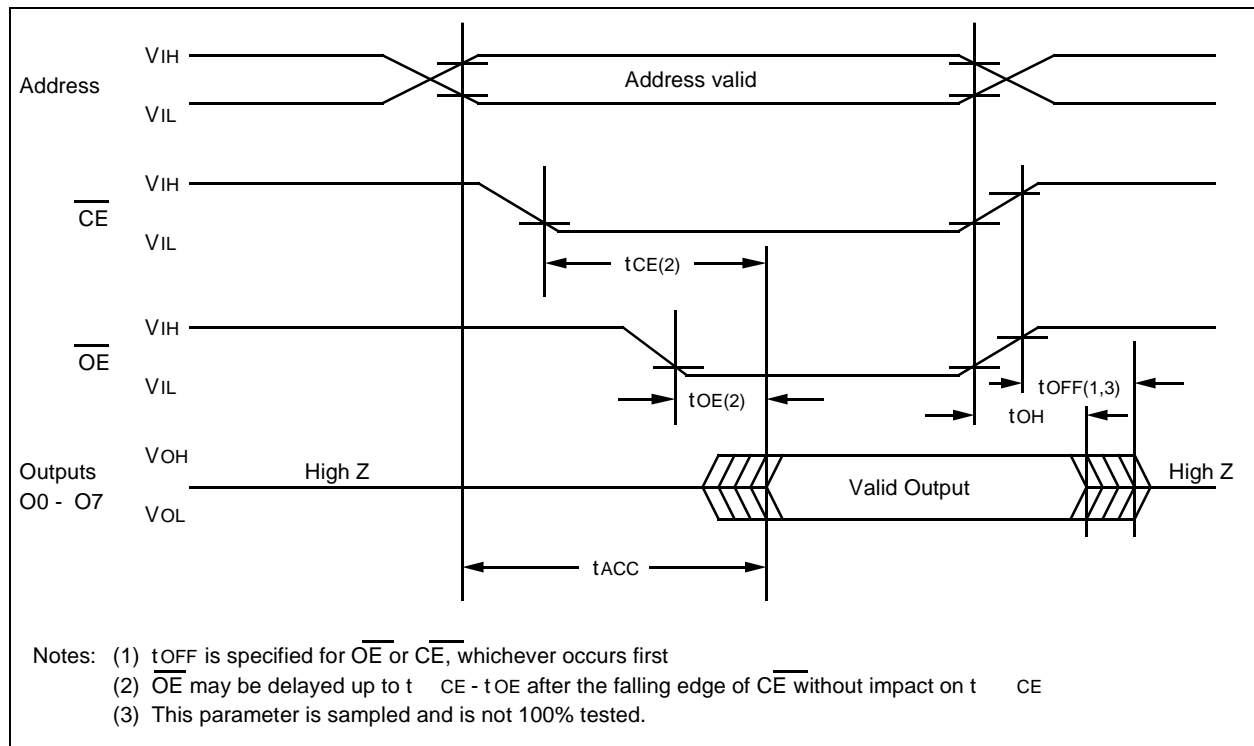

**TABLE 1-4: PROGRAMMING DC CHARACTERISTICS**

Ambient Temperature: $T_{amb} = 25^{\circ}\text{C} \pm 5^{\circ}\text{C}$ $V_{CC} = 6.5\text{V} \pm 0.25\text{V}$ , $V_{PP} = 13.0\text{V} \pm 0.25\text{V}$						
Parameter	Status	Symbol	Min	Max.	Units	Conditions
Input Voltages	Logic"1"	$V_{IH}$	2.0	$V_{CC}+1$	V	
	Logic"0"	$V_{IL}$	-0.1	0.8	V	
Input Leakage	—	$I_{LI}$	-10	10	$\mu\text{A}$	$V_{IN} = 0\text{V to } V_{CC}$
Output Voltages	Logic"1"	$V_{OH}$	2.4	0.45	V	$I_{OH} = -400\ \mu\text{A}$ $I_{OL} = 2.1\ \text{mA}$
	Logic"0"	$V_{OL}$			V	
VCC Current, program & verify	—	$I_{CC2}$	—	20	$\text{mA}$	Note 1
VPP Current, program	—	$I_{PP2}$	—	25	$\text{mA}$	Note 1
A9 Product Identification	—	$V_H$	11.5	12.5	V	

Note 1: VCC must be applied simultaneously or before VPP and removed simultaneously or after VPP.

**TABLE 1-5: PROGRAMMING AC CHARACTERISTICS**

for Program, Program Verify and Program Inhibit Modes		AC Testing Waveform: $V_{IH}=2.4\text{V}$ and $V_{IL}=0.45\text{V}$ ; $V_{OH}=2.0\text{V}$ ; $V_{OL}=0.8\text{V}$ Output Load: 1 TLL Load + 100pF Ambient Temperature: $T_{amb}=25^{\circ}\text{C} \pm 5^{\circ}\text{C}$ $V_{CC}= 6.5\text{V} \pm 0.25\text{V}$ , $V_{PP} = 13.0\text{V} \pm 0.25\text{V}$				
Parameter	Symbol	Min.	Max.	Units	Remarks	
Address Set-Up Time	tAS	2	—	$\mu\text{s}$		
Data Set-Up Time	tDS	2	—	$\mu\text{s}$		
Data Hold Time	tDH	2	—	$\mu\text{s}$		
Address Hold Time	tAH	0	—	$\mu\text{s}$		
Float Delay (2)	tDF	0	130	ns		
VCC Set-Up Time	tVCS	2	—	$\mu\text{s}$		
Program Pulse Width (1)	tPW	95	105	$\mu\text{s}$	100 $\mu\text{s}$ typical	
$\overline{\text{CE}}$ Set-Up Time	tCES	2	—	$\mu\text{s}$		
$\overline{\text{OE}}$ Set-Up Time	tOES	2	—	$\mu\text{s}$		
VPP Set-Up Time	tVPS	2	—	$\mu\text{s}$		
Data Valid from $\overline{\text{OE}}$	tOE	—	100	ns		

Note 1: For express algorithm, initial programming width tolerance is 100  $\mu\text{s} \pm 5\%$ .

2: This parameter is only sampled and not 100% tested. Output float is defined as the point where data is no longer driven (see timing diagram).

**FIGURE 1-2: PROGRAMMING WAVEFORMS**

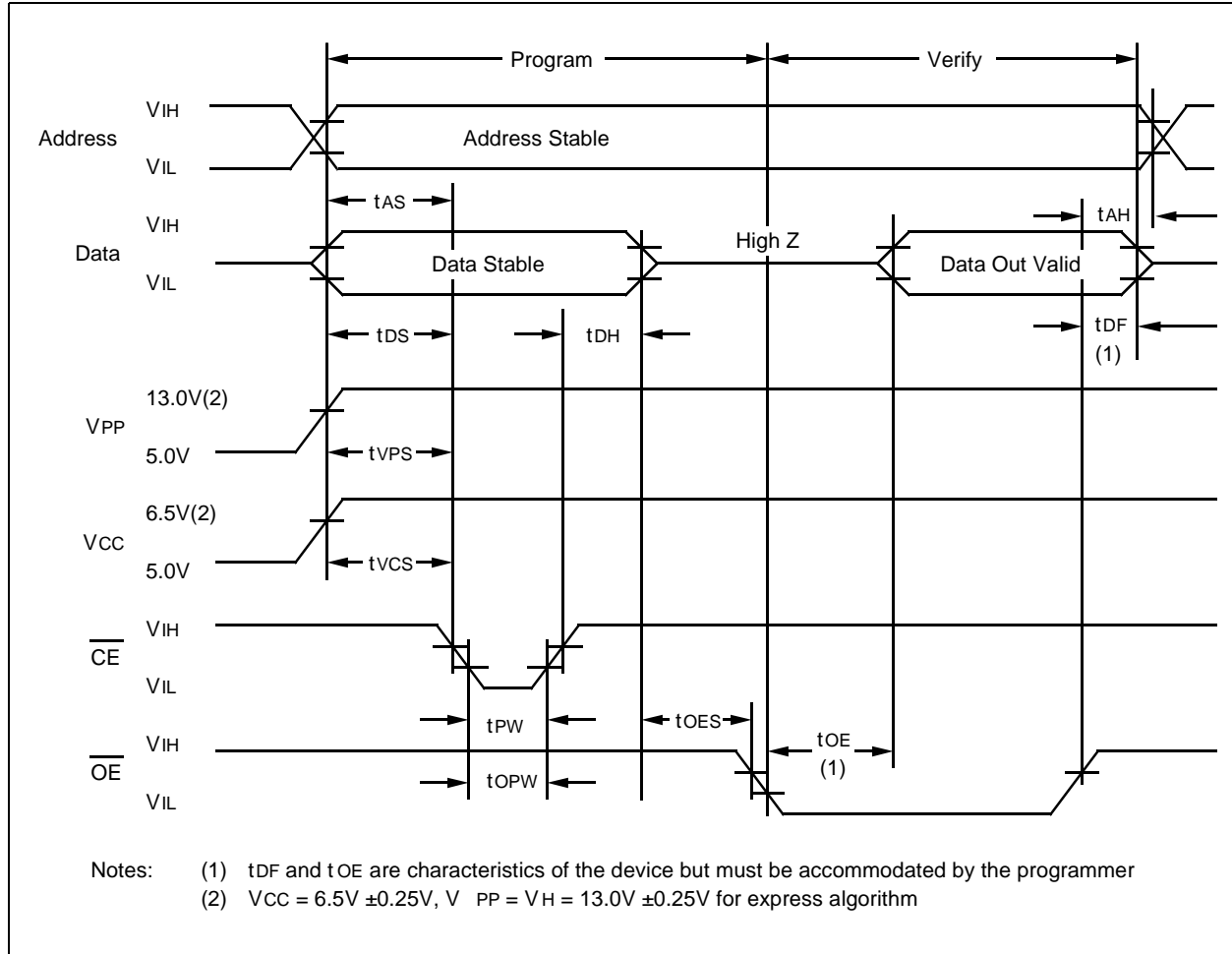

**TABLE 1-6: MODES**

Operation Mode	$\overline{CE}$	$\overline{OE}$	VPP	A9	O0 - O7
Read	VIL	VIL	VCC	X	DOUT
Program	VIL	VIH	VH	X	DIN
Program Verify	VIH	VIL	VH	X	DOUT
Program Inhibit	VIH	VIH	VH	X	High Z
Standby	VIH	X	VCC	X	High Z
Output Disable	VIL	VIH	VCC	X	High Z
Identity	VIL	VIL	VCC	VH	Identity Code

X = Don't Care

## 1.2 Read Mode

(See Timing Diagrams and AC Characteristics)

Read Mode is accessed when:

- the  $\overline{CE}$  pin is low to power up (enable) the chip
- the  $\overline{OE}$  pin is low to gate the data to the output pins

For Read operations, if the addresses are stable, the address access time ( $t_{ACC}$ ) is equal to the delay from  $\overline{CE}$  to output ( $t_{CE}$ ). Data is transferred to the output after a delay from the falling edge of  $\overline{OE}$  ( $t_{OE}$ ).

# 27LV256

## 1.3 Standby Mode

The standby mode is defined when the  $\overline{CE}$  pin is high ( $V_{IH}$ ) and a program mode is not defined. Output Disable

## 1.4 Output Enable

This feature eliminates bus contention in multiple bus microprocessor systems and the outputs go to a high impedance when the following condition is true:

- The  $\overline{OE}$  pin is high and program mode is not defined.

## 1.5 Programming Mode

The Express algorithm has been developed to improve on the programming throughput times in a production environment. Up to 10 100-microsecond pulses are applied until the byte is verified. No over-programming is required. A flowchart of the express algorithm is shown in Figure 1.

Programming takes place when:

- a)  $V_{CC}$  is brought to the proper voltage
- b)  $V_{PP}$  is brought to the proper  $V_H$  level
- c) the  $\overline{OE}$  pin is high
- d) the  $\overline{CE}$  pin is low

Since the erased state is "1" in the array, programming of "0" is required. The address to be programmed is set via pins A0-A14 and the data to be programmed is presented to pins O0-O7. When data and address are stable, a low-going pulse on the  $\overline{CE}$  line programs that location.

## 1.6 Verify

After the array has been programmed it must be verified to ensure that all the bits have been correctly programmed. This mode is entered when all of the following conditions are met:

- a)  $V_{CC}$  is at the proper level
- b)  $V_{PP}$  is at the proper  $V_H$  level
- c) the  $\overline{CE}$  pin is high
- d) the  $\overline{OE}$  line is low

## 1.7 Inhibit

When Programming multiple devices in parallel with different data, only  $\overline{CE}$  needs to be under separate control to each device. By pulsing the  $\overline{CE}$  line low on a particular device, that device will be programmed, and all other devices with  $\overline{CE}$  held high will not be programmed with the data although address and data are available on their input pins.

## 1.8 Identity Mode

In this mode specific data is outputted which identifies the manufacturer as Microchip Technology Inc. and device type. This mode is entered when Pin A9 is taken to  $V_H$  (11.5V to 12.5V). The  $\overline{CE}$  and  $\overline{OE}$  lines must be at  $V_{IL}$ . A0 is used to access any of the two non-erasable bytes whose data appears on O0 through O7.

Pin →	Input	Output									
Identity ↓	A0	0	0	0	0	0	0	0	0	0	H
		7	6	5	4	3	2	1	0		e
Manufacturer	$V_{IL}$	0	0	1	0	1	0	0	1	29	
Device Type*	$V_{IH}$	1	0	0	0	1	1	0	0	8C	

\* Code subject to change.

**FIGURE 1-3: PROGRAMMING EXPRESS ALGORITHM**

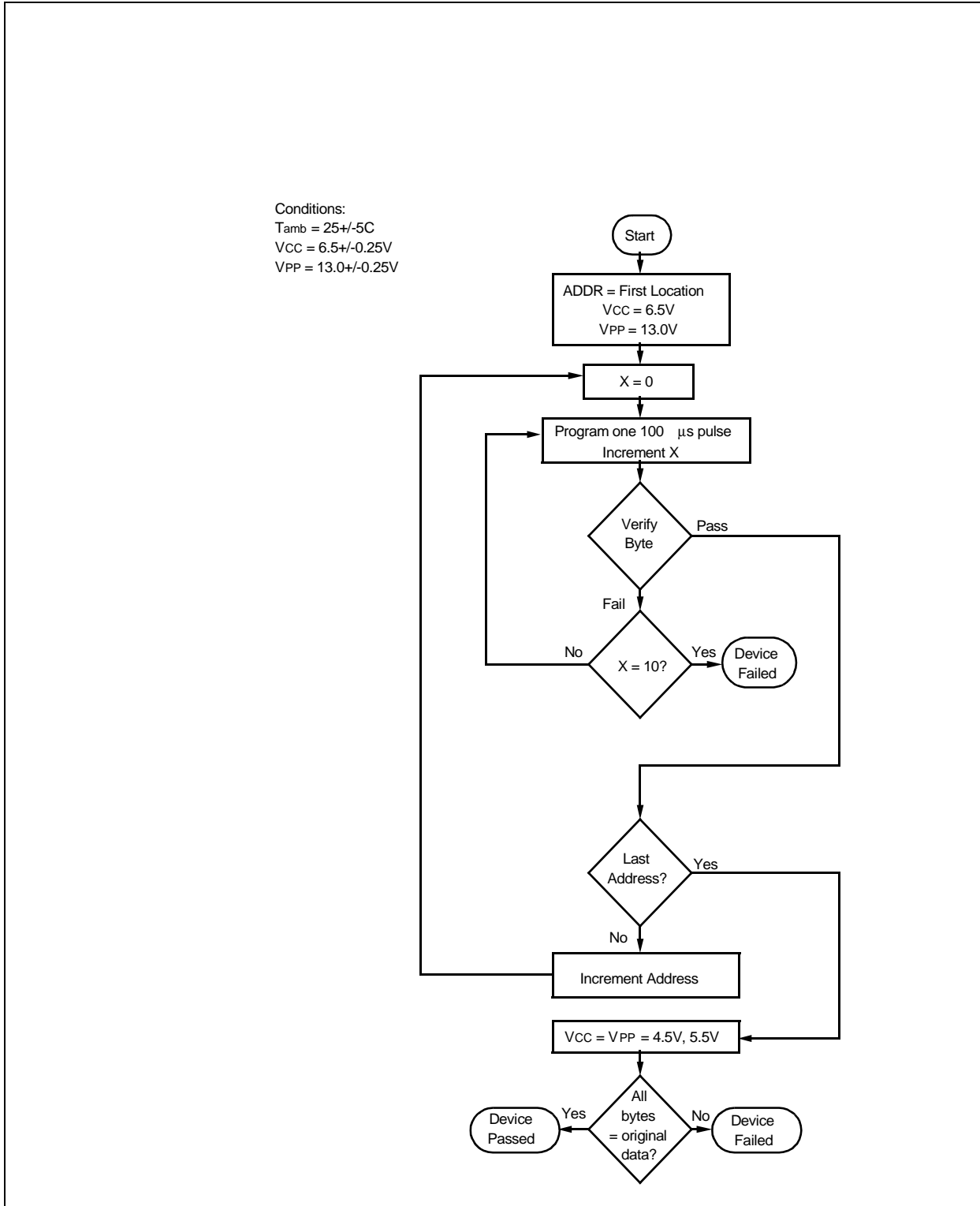

## 27LV256 Product Identification System

To order or to obtain information, e.g., on pricing or delivery, please use the listed part numbers, and refer to the factory or the listed sales offices.

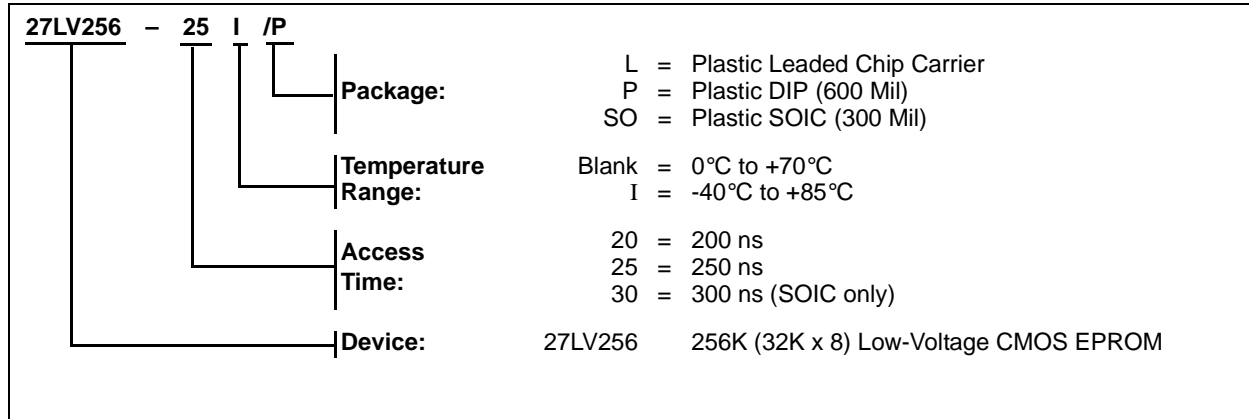



---

**Note the following details of the code protection feature on Microchip devices:**

- Microchip products meet the specification contained in their particular Microchip Data Sheet.
- Microchip believes that its family of products is one of the most secure families of its kind on the market today, when used in the intended manner and under normal conditions.
- There are dishonest and possibly illegal methods used to breach the code protection feature. All of these methods, to our knowledge, require using the Microchip products in a manner outside the operating specifications contained in Microchip's Data Sheets. Most likely, the person doing so is engaged in theft of intellectual property.
- Microchip is willing to work with the customer who is concerned about the integrity of their code.
- Neither Microchip nor any other semiconductor manufacturer can guarantee the security of their code. Code protection does not mean that we are guaranteeing the product as "unbreakable."

Code protection is constantly evolving. We at Microchip are committed to continuously improving the code protection features of our products. Attempts to break Microchip's code protection feature may be a violation of the Digital Millennium Copyright Act. If such acts allow unauthorized access to your software or other copyrighted work, you may have a right to sue for relief under that Act.

---

Information contained in this publication regarding device applications and the like is intended through suggestion only and may be superseded by updates. It is your responsibility to ensure that your application meets with your specifications. No representation or warranty is given and no liability is assumed by Microchip Technology Incorporated with respect to the accuracy or use of such information, or infringement of patents or other intellectual property rights arising from such use or otherwise. Use of Microchip's products as critical components in life support systems is not authorized except with express written approval by Microchip. No licenses are conveyed, implicitly or otherwise, under any intellectual property rights.

**Trademarks**

The Microchip name and logo, the Microchip logo, Accuron, dsPIC, KEELOQ, microID, MPLAB, PIC, PICmicro, PICSTART, PRO MATE, PowerSmart, rPIC, and SmartShunt are registered trademarks of Microchip Technology Incorporated in the U.S.A. and other countries.

AmpLab, FilterLab, MXDEV, MXLAB, PICMASTER, SEEVAL, SmartSensor and The Embedded Control Solutions Company are registered trademarks of Microchip Technology Incorporated in the U.S.A.

Analog-for-the-Digital Age, Application Maestro, dsPICDEM, dsPICDEM.net, dsPICworks, ECAN, ECONOMONITOR, FanSense, FlexROM, fuzzyLAB, In-Circuit Serial Programming, ICSP, ICEPIC, Migratable Memory, MPASM, MPLIB, MPLINK, MPSIM, PICkit, PICDEM, PICDEM.net, PICLAB, PICtail, PowerCal, PowerInfo, PowerMate, PowerTool, rLAB, rPICDEM, Select Mode, Smart Serial, SmartTel and Total Endurance are trademarks of Microchip Technology Incorporated in the U.S.A. and other countries.

SQTP is a service mark of Microchip Technology Incorporated in the U.S.A.

All other trademarks mentioned herein are property of their respective companies.

© 2004, Microchip Technology Incorporated, Printed in the U.S.A., All Rights Reserved.

 Printed on recycled paper.

**QUALITY MANAGEMENT SYSTEM  
CERTIFIED BY DNV  
== ISO/TS 16949:2002 ==**

*Microchip received ISO/TS-16949:2002 quality system certification for its worldwide headquarters, design and wafer fabrication facilities in Chandler and Tempe, Arizona and Mountain View, California in October 2003. The Company's quality system processes and procedures are for its PICmicro® 8-bit MCUs, KEELOQ® code hopping devices, Serial EEPROMs, microperipherals, nonvolatile memory and analog products. In addition, Microchip's quality system for the design and manufacture of development systems is ISO 9001:2000 certified.*



## WORLDWIDE SALES AND SERVICE

### AMERICAS

#### Corporate Office

2355 West Chandler Blvd.  
Chandler, AZ 85224-6199  
Tel: 480-792-7200  
Fax: 480-792-7277  
Technical Support: 480-792-7627  
Web Address: www.microchip.com

#### Atlanta

3780 Mansell Road, Suite 130  
Alpharetta, GA 30022  
Tel: 770-640-0034  
Fax: 770-640-0307

#### Boston

2 Lan Drive, Suite 120  
Westford, MA 01886  
Tel: 978-692-3848  
Fax: 978-692-3821

#### Chicago

333 Pierce Road, Suite 180  
Itasca, IL 60143  
Tel: 630-285-0071  
Fax: 630-285-0075

#### Dallas

16200 Addison Road, Suite 255  
Addison Plaza  
Addison, TX 75001  
Tel: 972-818-7423  
Fax: 972-818-2924

#### Detroit

Tri-Atria Office Building  
32255 Northwestern Highway, Suite 190  
Farmington Hills, MI 48334  
Tel: 248-538-2250  
Fax: 248-538-2260

#### Kokomo

2767 S. Albright Road  
Kokomo, IN 46902  
Tel: 765-864-8360  
Fax: 765-864-8387

#### Los Angeles

25950 Acero St., Suite 200  
Mission Viejo, CA 92691  
Tel: 949-462-9523  
Fax: 949-462-9608

#### San Jose

1300 Terra Bella Avenue  
Mountain View, CA 94043  
Tel: 650-215-1444  
Fax: 650-961-0286

#### Toronto

6285 Northam Drive, Suite 108  
Mississauga, Ontario L4V 1X5, Canada  
Tel: 905-673-0699  
Fax: 905-673-6509

### ASIA/PACIFIC

#### Australia

Microchip Technology Australia Pty Ltd  
Unit 32 41 Rawson Street  
Epping 2121, NSW  
Sydney, Australia  
Tel: 61-2-9868-6733  
Fax: 61-2-9868-6755

#### China - Beijing

Unit 706B  
Wan Tai Bei Hai Bldg.  
No. 6 Chaoyangmen Bei Str.  
Beijing, 100027, China  
Tel: 86-10-85282100  
Fax: 86-10-85282104

#### China - Chengdu

Rm. 2401-2402, 24th Floor,  
Ming Xing Financial Tower  
No. 88 TIDU Street  
Chengdu 610016, China  
Tel: 86-28-86766200  
Fax: 86-28-86766599

#### China - Fuzhou

Unit 28F, World Trade Plaza  
No. 71 Wusi Road  
Fuzhou 350001, China  
Tel: 86-591-7503506  
Fax: 86-591-7503521

#### China - Hong Kong SAR

Unit 901-6, Tower 2, Metroplaza  
223 Hing Fong Road  
Kwai Fong, N.T., Hong Kong  
Tel: 852-2401-1200  
Fax: 852-2401-3431

#### China - Shanghai

Room 701, Bldg. B  
Far East International Plaza  
No. 317 Xian Xia Road  
Shanghai, 200051  
Tel: 86-21-6275-5700  
Fax: 86-21-6275-5060

#### China - Shenzhen

Rm. 1812, 18/F, Building A, United Plaza  
No. 5022 Binhe Road, Futian District  
Shenzhen 518033, China  
Tel: 86-755-82901380  
Fax: 86-755-8295-1393

#### China - Shunde

Room 401, Hongjian Building, No. 2  
Fengxiangnan Road, Ronggui Town, Shunde  
District, Foshan City, Guangdong 528303, China  
Tel: 86-757-28395507 Fax: 86-757-28395571

#### China - Qingdao

Rm. B505A, Fullhope Plaza,  
No. 12 Hong Kong Central Rd.  
Qingdao 266071, China  
Tel: 86-532-5027355 Fax: 86-532-5027205

#### India

Divyasree Chambers  
1 Floor, Wing A (A3/A4)  
No. 11, O'Shaughnessy Road  
Bangalore, 560 025, India  
Tel: 91-80-22290061 Fax: 91-80-22290062

#### Japan

Yusen Shin Yokohama Building 10F  
3-17-2, Shin Yokohama, Kohoku-ku,  
Yokohama, Kanagawa, 222-0033, Japan  
Tel: 81-45-471- 6166 Fax: 81-45-471-6122

#### Korea

168-1, Youngbo Bldg. 3 Floor  
Samsung-Dong, Kangnam-Ku  
Seoul, Korea 135-882  
Tel: 82-2-554-7200 Fax: 82-2-558-5932 or  
82-2-558-5934

#### Singapore

200 Middle Road  
#07-02 Prime Centre  
Singapore, 188980  
Tel: 65-6334-8870 Fax: 65-6334-8850

#### Taiwan

Kaohsiung Branch  
30F - 1 No. 8  
Min Chuan 2nd Road  
Kaohsiung 806, Taiwan  
Tel: 886-7-536-4816  
Fax: 886-7-536-4817

#### Taiwan

Taiwan Branch  
11F-3, No. 207  
Tung Hua North Road  
Taipei, 105, Taiwan  
Tel: 886-2-2717-7175 Fax: 886-2-2545-0139

#### Taiwan

Taiwan Branch  
13F-3, No. 295, Sec. 2, Kung Fu Road  
Hsinchu City 300, Taiwan  
Tel: 886-3-572-9526  
Fax: 886-3-572-6459

### EUROPE

#### Austria

Durisolstrasse 2  
A-4600 Wels  
Austria  
Tel: 43-7242-2244-399  
Fax: 43-7242-2244-393

#### Denmark

Regus Business Centre  
Lautrup høj 1-3  
Ballerup DK-2750 Denmark  
Tel: 45-4420-9895 Fax: 45-4420-9910

#### France

Parc d'Activite du Moulin de Massy  
43 Rue du Saule Trapu  
Batiment A - 1er Etage  
91300 Massy, France  
Tel: 33-1-69-53-63-20  
Fax: 33-1-69-30-90-79

#### Germany

Steinheilstrasse 10  
D-85737 Ismaning, Germany  
Tel: 49-89-627-144-0  
Fax: 49-89-627-144-44

#### Italy

Via Salvatore Quasimodo, 12  
20025 Legnano (MI)  
Milan, Italy  
Tel: 39-0331-742611  
Fax: 39-0331-466781

#### Netherlands

Waegenburghtplein 4  
NL-5152 JR, Drunen, Netherlands  
Tel: 31-416-690399  
Fax: 31-416-690340

#### United Kingdom

505 Eskdale Road  
Winnersh Triangle  
Wokingham  
Berkshire, England RG41 5TU  
Tel: 44-118-921-5869  
Fax: 44-118-921-5820