



CMOS SRAM 256K-BIT(32Kx8)

N341256

■ Features

- CMOS SRAM organized as 32,768 x 8bits
- Single +5.0V($\pm 10\%$) Power Supply
- High Speed Access time : 12/15/20/25ns
- Low power operation
 - Active : 180mA(max.)
 - Standby : 60mA(max.)

● Package

- 28pin Plastic DIP(300mil)
- 28pin Plastic SOJ(300mil)
- 28pin Plastic TSOP(Type-1)

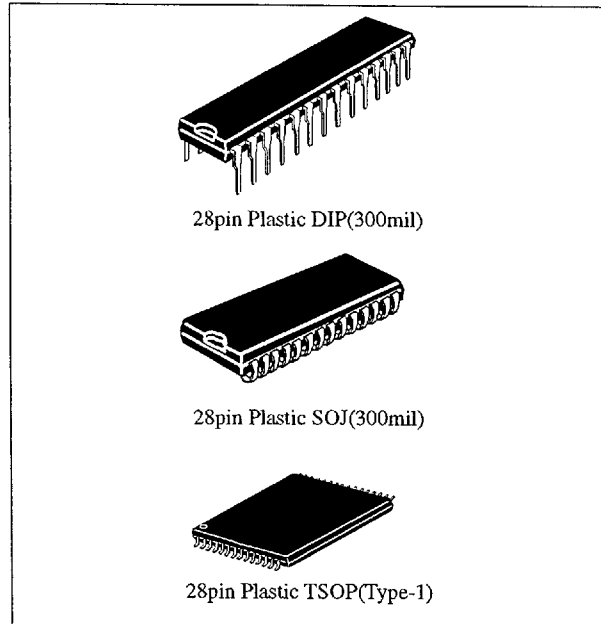

■ Description

The N341256 is a high performance CMOS static RAM organized as 32,768 x 8bits.

Writing to this device is accomplished when the write enable (\overline{WE}) and the chip select (\overline{CE}) inputs are both Low.

Reading is accomplished when \overline{WE} is High and \overline{CE} and the output enable (\overline{OE}) are both Low.

The N341256 operates from a single +5.0V power supply and all inputs are fully TTL compatible.

■ Functional Block Diagram

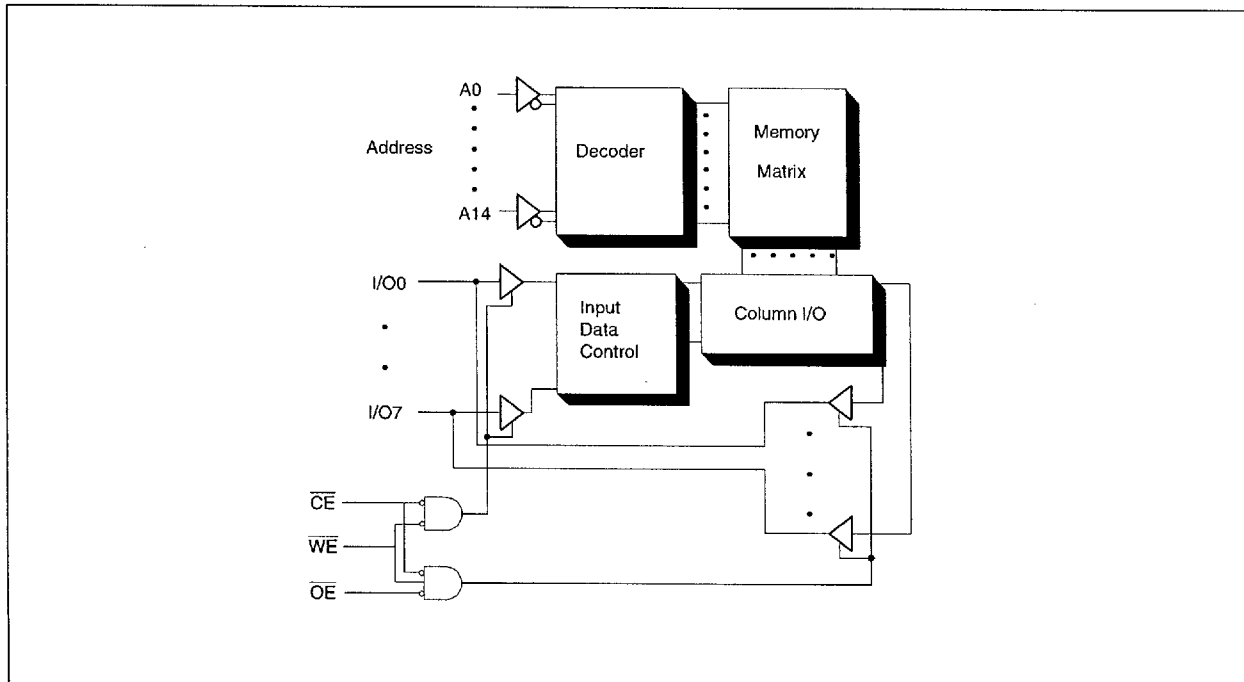

■ Pin Configuration

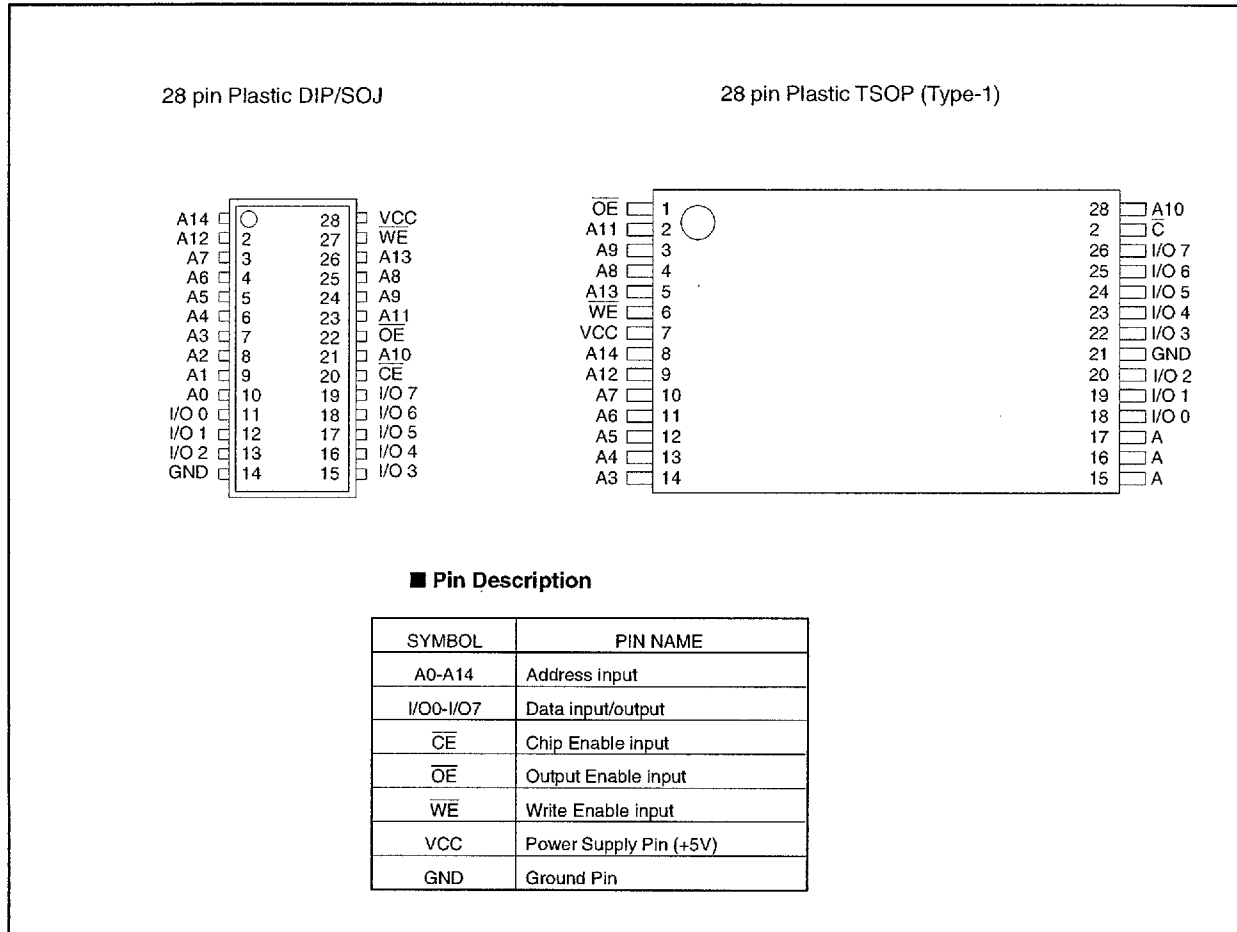

■ Pin Description

SYMBOL	PIN NAME
A0-A14	Address input
I/O0-I/O7	Data input/output
\overline{CE}	Chip Enable input
\overline{OE}	Output Enable input
\overline{WE}	Write Enable input
VCC	Power Supply Pin (+5V)
GND	Ground Pin

■ Mode Selection Table

\overline{OE}	\overline{WE}	\overline{CE}	I/O	MODE
X	X	High	High Impedance	Standby
Low	High	Low	Data out	Read
X	Low	Low	Data in	Write
High	High	Low	High Impedance	Output disable

■ Absolute Maximum Ratings

Symbol	Rating	Value	Unit
VTERM	Terminal Voltage with Respect to GND	-0.5 to 7.0	V
TA	Operating Temperature	0 to 70	°C
TBIAS	Temperature Under Bias	-55 to 125	°C
TSTG	Storage Temperature	-55 to 125	°C
PT	Power Dissipation	1.0	W
IOUT	DC Output Current	50	mA

NOTICE

Stress greater than those listed under ABSOLUTE MAXIMUM RATINGS may cause permanent damage to the device. This is a stress rating only and functional operation of the device at these or any other conditions above those indication in the operational section of this specification is not implied. Exposure to absolute maximum rating conditions for extended periods may affect reliability.

■ Recommended Operating Conditions
Recommended Operating Temperature and Supply Voltage

Ambient Temperature	GND	VCC
0°C to 70°C	0V	5.0V ± 10%

Recommended DC Operating Conditions

Symbol	Parameter	Min.	Typ.	Max.	Unit
VCC	Supply Voltage	4.5	5.0	5.5	V
GND	Supply Voltage	0	0	0	V
VIH	Input High Voltage	2.2	-	VCC + 0.5	V
VIL	Input Low Voltage	-0.5	-	0.8	V

Notes : VIL(min) = -3.0V for pulse width less than 20ns.

■ Capacitance

(TA = +25°C, f = 1.0MHz)

Symbol	Parameter	Condition	Max.	Unit
CIN	Input Capacitance	VIN = 0V	8	pF
COUT	Output Capacitance	VOUT = 0V	8	pF

■ DC Electrical Characteristics

($V_{CC} = 5.0V \pm 10\%$, $T_A = 0$ to $+70^\circ C$, $V_{LC} \leq 0.2V$, $V_{HC} \geq V_{CC} - 0.2V$)

Symbol	Parameter	N341256	N341256	N341256	N341256	Unit
		-12	-15	-20	-25	
ICC	Dynamic Operating Current					
	$\overline{CE} \leq V_{IL}$, $V_{CC} = \max$, $f = f_{max}$, $I_{OUT} = 0mA$ $V_{IN} \geq V_{IH}$ or $\leq V_{IL}$	180	170	160	150	mA
ISB	Standby Power Supply Current (TTL level)	60	50	40	35	mA
	$\overline{CE} \geq V_{IH}$, $V_{CC} = \max$, $f = f_{max}$, $V_{IN} \geq V_{IH}$ or $\leq V_{IL}$					
ISB1	Full Standby Power Supply Current (CMOS level)	10	10	10	10	mA
	$\overline{CE} \geq V_{HC}$, $V_{CC} = \max$, $f = 0$, $V_{IN} \geq V_{HC}$ or $\leq V_{LC}$					

DC Electrical Characteristics(1)

($V_{CC} = 5.0V \pm 10\%$)

Symbol	Parameter	Test Condition	N341256		Unit
			Min.	Max.	
I _{ILI}	Input Leakage Current	$V_{CC} = \max$, $V_{IN} = GND$ to V_{CC}	-	5	μA
I _{ILO}	Output Leakage Current	$V_{CC} = \max$, $\overline{CE} \geq V_{IH}$, $V_{OUT} = GND$ to V_{CC}	-	5	μA
VOL	Output low voltage	$I_{OL} = 8mA$, $V_{CC} = \min$	-	0.4	V
		$I_{OL} = 10mA$, $V_{CC} = \min$	-	0.5	V
VOH	Output high voltage	$I_{OH} = -4mA$, $V_{CC} = \min$	2.4	-	V

■ AC Test Conditions

Input pulse levels	GND to 3V
Input rise and fall times	5ns
Input timing reference levels	1.5V
Output timing reference levels	1.5V
Output load	See figure 1 and 2

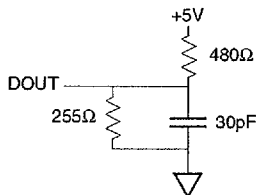

Figure 1. Output load Equivalent

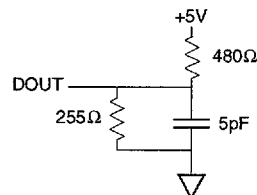

Figure 2. Output load Equivalent
(for t_{LZCE}, t_{HZCE}, t_{LZWE}, t_{HZWE}, t_{LZOE}, t_{HZOE})

■ AC Electrical Characteristics

 (V_{cc} = 5.0V ± 10%, T_A = 0 to +70°C)

Description	Symbol	N341256-12		N341256-15		N341256-20		N341256-25		Unit
		Min.	Max.	Min.	Max.	Min.	Max.	Min.	Max.	
Read Cycle										
Read Cycle time	t _{RC}	12		15		20		25		ns
Address access time	t _{AA}		12		15		20		25	ns
Chip enable access time	t _{ACE}		12		15		20		25	ns
Output hold from address change	t _{OH}	3		3		3		3		ns
Chip enable to output in low-Z	t _{LZCE}	5		5		5		5		ns
Chip disable to output high-Z	t _{HZCE}		5		5		5		10	ns
Chip enable t _i power up time	t _{PU}	0		0		0		0		ns
Chip enable t _i power down time	t _{PD}		12		15		20		25	ns
Output enable access time	t _{AOE}		6		8		10		12	ns
Output enable to output in low-Z	t _{LZOE}	0		0		0		0		ns
Output disable to output in high-Z	t _{HZOE}		5		5		5		10	ns

 Note : t_{LZCE}, t_{HZCE}, t_{LZOE}, t_{HZOE}, t_{PU} and t_{PD} are simulated values.

 (V_{cc} = 5.0V ± 10%, T_A = 0 to +70°C)

Description	Symbol	N341256-12		N341256-15		N341256-20		N341256-25		Unit
		Min.	Max.	Min.	Max.	Min.	Max.	Min.	Max.	
Write Cycle										
Write Cycle time	t _{WC}	12		15		20		25		ns
Chip enable to end of write	t _{CW}	10		12		13		15		ns
Address valid to end of write	t _{AW}	10		12		13		15		ns
Address set-up time	t _{AS}	0		0		0		0		ns
Address hold from end of write	t _{AH}	0		0		0		0		ns
Write pulse width	t _{WP}	10		11		12		15		ns
Data set-up time	t _{DS}	7		8		9		10		ns
Data hold time	t _{DH}	0		0		0		0		ns
Write disable to output in low-Z	t _{LZWE}	0		0		0		0		ns
Write enable to output in high-Z	t _{HZWE}		3		3		3		5	ns

 Note : t_{LZWE} and t_{HZWE} are simulated values.

■ AC Timing Waveforms

Read Cycle No.1

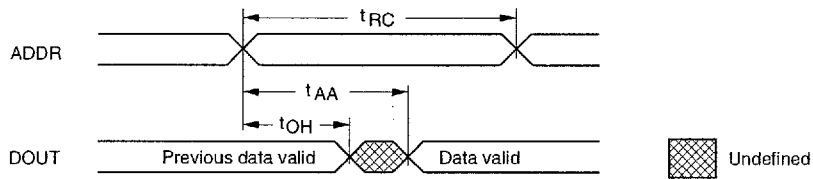

Read Cycle No.2

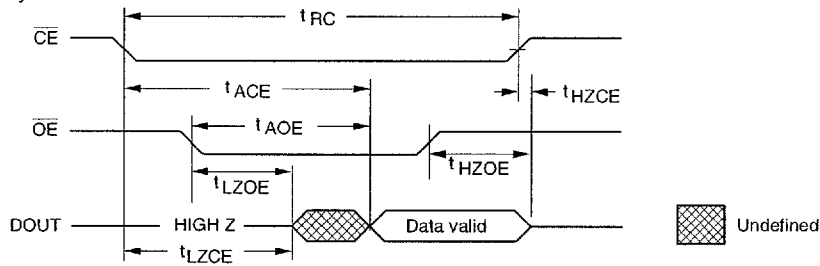

Write Cycle No.1 (Write Enable Controlled)

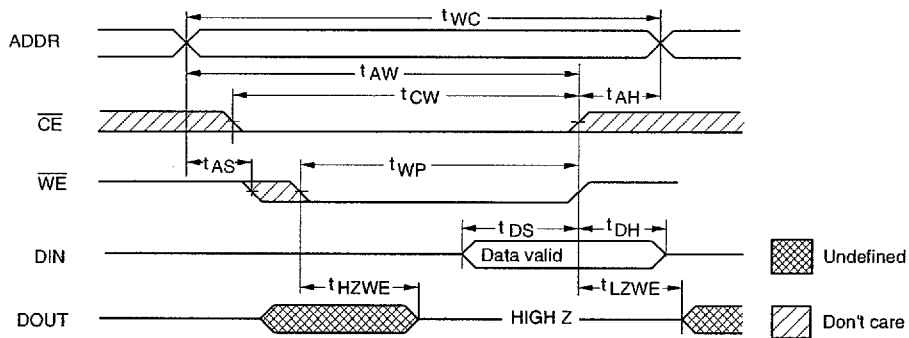

Write Cycle No.2 (Chip Enable Controlled)

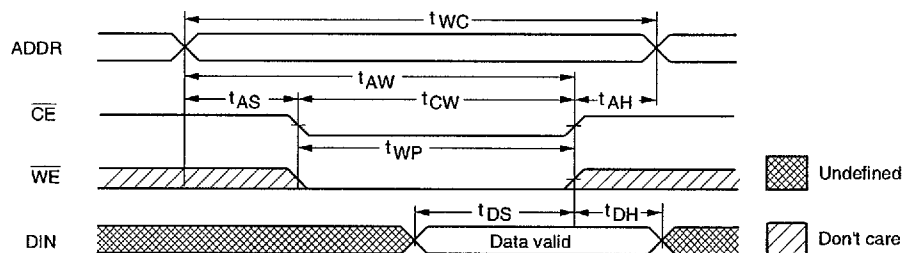

■ Ordering informations

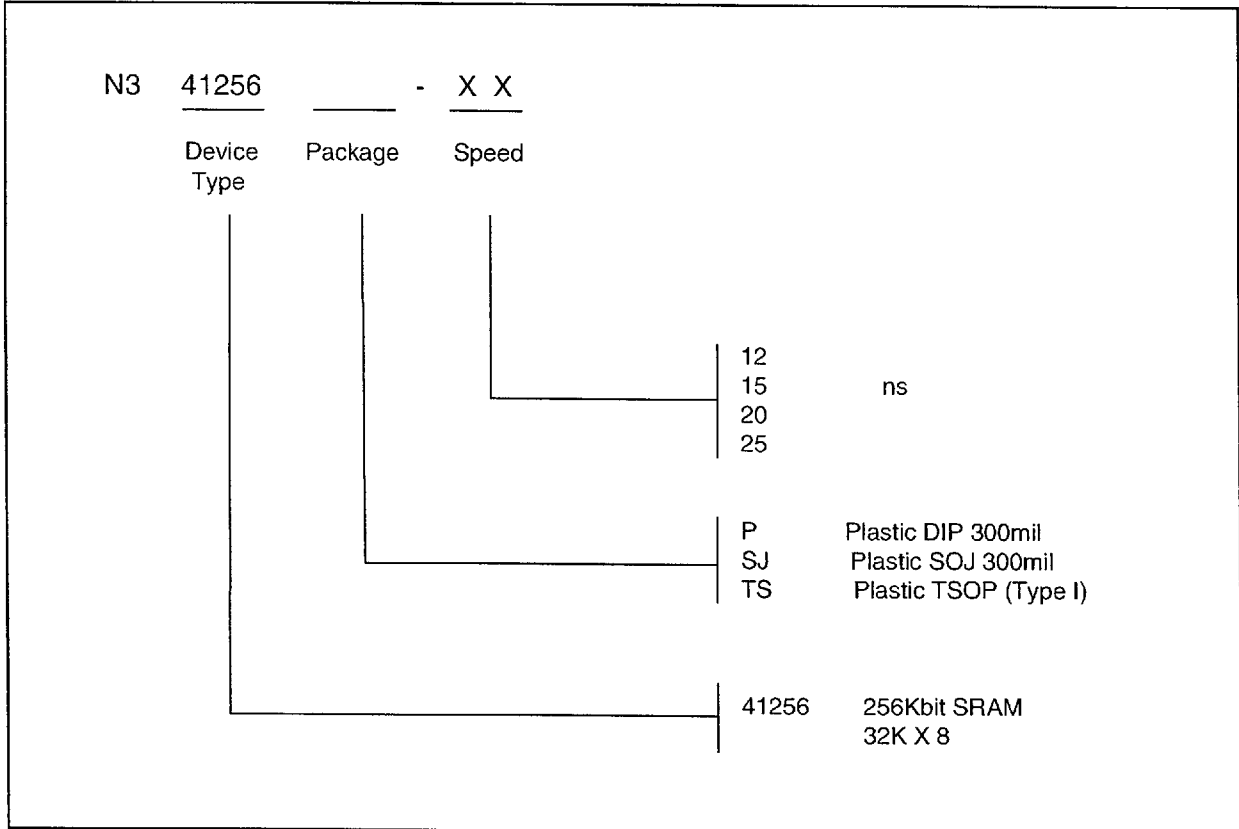

PART NO.	Access Time (ns)	Operating Current (mA)	Power down Standby Current (mA)	Package
N341256P-12	12	180	60	28Pin Plastic DIP (300mil)
N341256SJ-12	12	180	60	28Pin Plastic SOJ (300mil)
N341256TS-12	12	180	60	28Pin Plastic TSOP (Type-1)
N341256P-15	15	170	50	28Pin Plastic DIP (300mil)
N341256SJ-15	15	170	50	28Pin Plastic SOJ (300mil)
N341256TS-15	15	170	50	28Pin Plastic TSOP (Type-1)
N341256P-20	20	160	40	28Pin Plastic DIP (300mil)
N341256SJ-20	20	160	40	28Pin Plastic SOJ (300mil)
N341256TS-20	20	160	40	28Pin Plastic TSOP (Type-1)
N341256P-25	25	150	35	28Pin Plastic DIP (300mil)
N341256SJ-25	25	150	35	28Pin Plastic SOJ (300mil)
N341256TS-25	25	150	35	28Pin Plastic TSOP (Type-1)

■ Package Information

28pin Plastic DIP (300mil)

ITEM	MILLIMETERS	INCHES
A	35.00 ± 0.20	1.378 ± 0.008
B	7.20 ± 0.10	0.283 ± 0.004
C	2.54 TYP.	0.10 TYP.
D	0.45 ± 0.08	0.018 ± 0.003
E	1.40 ± 0.20	0.055 ± 0.008
F	7.00 +0.70 -0.50	0.276 +0.028 -0.008
G	4.00 +0.40 -0.20	0.157 +0.016 -0.008
H	3.00 ± 0.30	0.118 ± 0.012
I	3.30 +0.20 -0.0	0.130 +0.008 -0.0
J	0.70 ± 0.20	0.028 ± 0.008
K	9.44 ± 0.50	0.372 ± 0.020
L	8.10 ± 0.10	0.319 ± 0.004
M	15°	15°
N	0.25 ± 0.05	0.010 ± 0.002

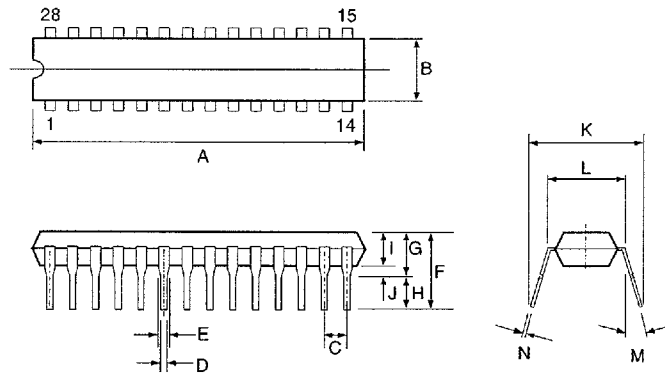

28pin Plastic SOJ (300mil)

ITEM	MILLIMETERS	INCHES
A	18.10 ± 0.10	0.713 ± 0.004
B	7.60 ± 0.10	0.299 ± 0.004
C	1.27 TYP.	0.05 TYP.
D	0.46 ± 0.08	0.018 ± 0.003
E	0.71	0.028
F	3.43 +0.10 -0.30	0.135 +0.004 -0.012
G	0.63 MIN.	0.025 MIN.
H	2.60 ± 0.10	0.102 ± 0.004
I	8.60 +0.10 -0.20	0.339 +0.004 -0.008
J	6.85 ± 0.15	0.270 ± 0.006
K	2.35 ± 0.10	0.093 ± 0.006
L	0.25	0.010
M	7°	7°

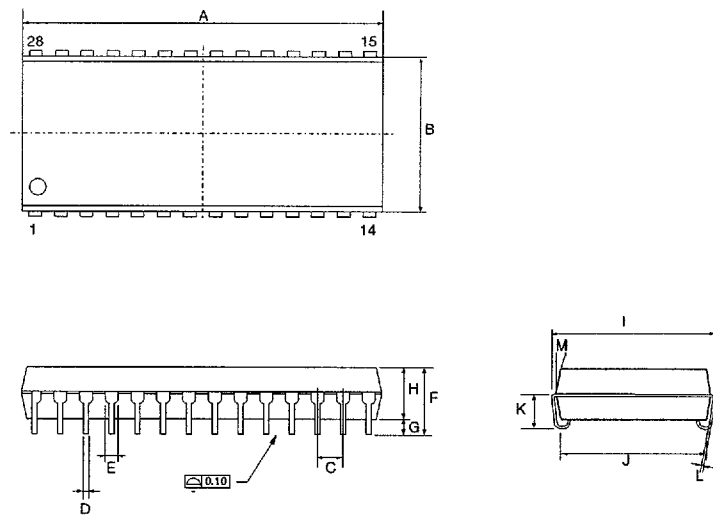

28pin Plastic TSOP (Type 1)

ITEM	MILLIMETERS	INCHES
A	13.40 BSC.	0.528 BSC.
B	11.80 BSC.	0.465 BSC.
C	8.00 BSC.	0.1315 BSC.
D	0.10 to 0.21	0.004 to 0.008
E	0.22 ± 0.05	0.009 ± 0.002
F	0.55 BSC.	0.0217 BSC.
G	0.05 to 0.15	0.002 to 0.006
H	1.00 ± 0.05	0.039 ± 0.002
I	1.20 MAX.	0.047 MAX.
J	0.55 +0.15 -0.05	0.022 +0.006 -0.002
K	0 to 6°	0 to 6°

