

65,536 WORDS x 8 BITS CMOS ONE TIME PROGRAMMABLE READ ONLY MEMORY

DESCRIPTION

The TC54512AP/AF is a 65,536 word x 8 bit CMOS one time programmable read only memory, and molded in a 28 pin plastic package. For read operation, the TC54512AP/AF's access time is 150ns/200ns, and the TC54512AP/AF operates from a single 5-volt power supply and has low power standby mode which reduces the power dissipation without increasing access time. The standby mode is achieved by applying a TTL-high level signal to the \overline{CE} input. Advanced CMOS technology reduces the maximum active current to 30mA/5.9MHz and standby current to 100 μ A. The electrical characteristics and programming method are the same as U.V. EPROM TC57512AD's. Once programmed, the TC54512AP/AF cannot be erased because of using plastic DIP without transparent window.

FEATURES

- Peripheral circuit: CMOS Memory cell : N-MOS
- Fast access time:
TC54512AP/AF-15 150ns
TC54512AP/AF-20 200ns
- Low power dissipation
Active : 30mA/5.9MHz
Standby: 100 μ A
- Full static operation
- High speed programming mode I, II
- Inputs and outputs TTL compatible
- Standard 28 pin DIP plastic package: TC54512AP
28 pin plastic Flat Package : TC54512AF

PIN CONNECTION (TOP VIEW)

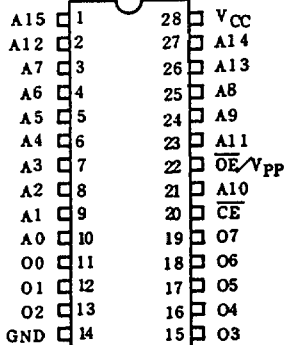

PIN NAMES

AO ~ A15	Address Inputs
O0 ~ O7	Outputs (Inputs)
\overline{CE}	Chip Enable Input
\overline{OE}/V_{pp}	Output Enable Input / Program Supply Voltage
VCC	Power Supply Voltage (+5V)
GND	Ground

BLOCK DIAGRAM

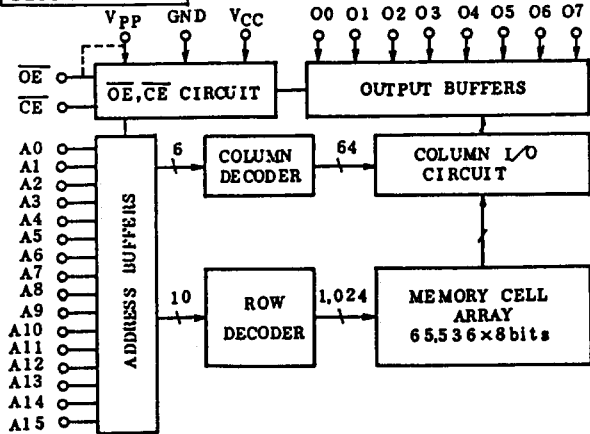

MODE SELECTION

MODE	PIN	\overline{CE} (20)	\overline{OE}/V_{pp} (22)	VCC (28)	O0 ~ O7 (11 ~ 13, 15 ~ 19)	POWER
Read		L	L	5V	Data Out	Active
Output Deselect	*	H	High Impedance			
Standby	H	*	High Impedance			
Program		L	Vpp	6V1) 2)	Data In	Standby
Program Inhibit	H	Vpp	High Impedance			
Program Verify	L	L	Data Out			

*: H or L 1): HIGH SPEED PROGRAMMING MODE I
2): HIGH SPEED PROGRAMMING MODE II

TC54512AP-15, TC54512AP-20 TC54512AF-15, TC54512AF-20

MAXIMUM RATINGS

SYMBOL	ITEM	RATING	UNIT
V _{CC}	V _{CC} Power Supply Voltage	-0.6 ~ 7.0	V
V _{PP}	Program Supply Voltage	-0.6 ~ 14.0	V
V _{IN}	Input Voltage	-0.6 ~ 7.0	V
V _{I/O}	Input/Output Voltage	-0.6 ~ V _{CC} +0.5	V
P _D	Power Dissipation	1.5	W
T _{SOLDER}	Soldering Temperature-Time	260 · 10	°C·sec
T _{STG}	Storage Temperature	-65 ~ 125	°C
T _{OPR}	Operating Temperature	-40 ~ 85	°C

READ OPERATION

D.C. AND A.C. RECOMMENDED OPERATING CONDITIONS

SYMBOL	PARAMETER	TC54512AP/AF-15/TC54512AP/AF-20
T _a	Operating Temperature	-40 ~ 85°C
V _{CC}	V _{CC} Power Supply Voltage	5V±5%

D.C. AND OPERATING CHARACTERISTICS

SYMBOL	PARAMETER	CONDITION	MIN.	TYP.	MAX.	UNIT	
I _{LI}	Input Current	V _{IN} =0 ~ V _{CC}	-	-	±10	μA	
I _{LO}	Output Leakage Current	V _{OUT} =0.4 ~ V _{CC}	-	-	±10	μA	
I _{CCO1}	Operating Current	$\overline{CE}=0V$ I _{OUT} =0mA	f=5.9MHz	-	-	30	mA
I _{CCO2}			f=1MHz	-	-	15	
I _{CCS1}	Standby Current	$\overline{CE}=V_{IH}$	-	-	1	mA	
I _{CCS2}		$\overline{CE}=V_{CC}-0.2V$	-	-	100		μA
V _{IH}	Input High Voltage	-	2.2	-	V _{CC} +0.3	V	
V _{IL}	Input Low Voltage	-	-0.3	-	0.8	V	
V _{OH}	Output High Voltage	I _{OH} =-400μA	2.4	-	-	V	
V _{OL}	Output Low Voltage	I _{OL} =2.1mA	-	-	0.4	V	
I _{PPI}	V _{PP} Current	V _{PP} =0 ~ V _{CC} +0.6	-	-	±10	μA	

A.C. CHARACTERISTICS

SYMBOL	PARAMETER	TEST CONDITION	TC54512AP/AF-15		TC54512AP/AF-20		UNIT
			MIN.	MAX.	MIN.	MAX.	
t_{ACC}	Address Access Time	$\overline{CE}=\overline{OE}=V_{IL}$	-	150	-	200	ns
t_{CE}	\overline{CE} to Output Valid	$\overline{OE}=V_{IL}$	-	150	-	200	ns
t_{OE}	\overline{OE} to Output Valid	$\overline{CE}=V_{IL}$	-	70	-	70	ns
t_{DF1}	\overline{CE} to Output in High-Z	$\overline{OE}=V_{IL}$	0	60	0	60	ns
t_{DF2}	\overline{OE} to Output in High-Z	$\overline{CE}=V_{IL}$	0	60	0	60	ns
t_{OH}	Output Data Hold Time	$\overline{CE}=\overline{OE}=V_{IL}$	0	-	0	-	ns

A.C. TEST CONDITIONS

- Output Load : 1 TTL Gate and $C_L=100pF$
- Input Pulse Rise and Fall Times : 10ns Max.
- Input Pulse Levels : 0.45V ~ 2.4V
- Timing Measurement Reference Level: Inputs 0.8V and 2.2V, Outputs 0.8V and 2.0V

CAPACITANCE *($T_a=25^\circ C$, $f=1MHz$)

SYMBOL	PARAMETER	TEST CONDITION	MIN.	TYP.	MAX.	UNIT
C_{IN1}	Input Capacitance	$V_{IN}=0V$	-	4	6	pF
C_{IN2}	\overline{OE}/V_{pp} Input Capacitance	$V_{IN}=0V$	-	50	60	pF
C_{OUT}	Output Capacitance	$V_{OUT}=V$	-	8	12	pF

* This parameter is periodically sampled and is not 100% tested.

TIMING WAVEFORMS

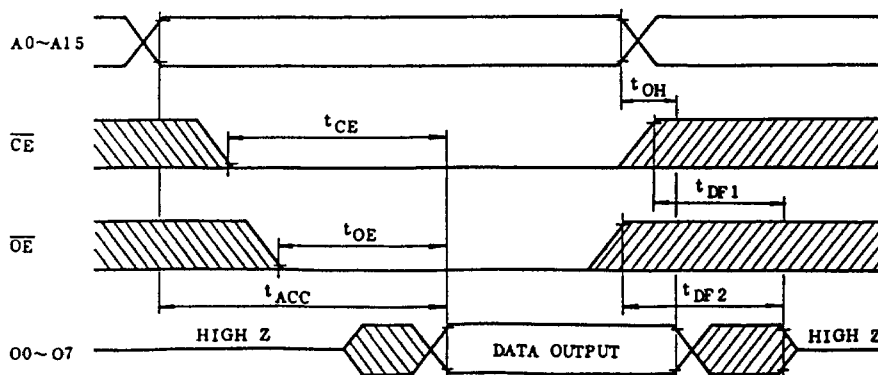

TC54512AP-15, TC54512AP-20 TC54512AF-15, TC54512AF-20

HIGH SPEED PROGRAM MODE I

DC RECOMMENDED OPERATING CONDITIONS

SYMBOL	PARAMETER	MIN.	TYP.	MAX.	UNIT
V _{IH}	Input High Voltage	2.2	-	V _{CC} +1.0	V
V _{IL}	Input Low Voltage	-0.3	-	0.8	V
V _{CC}	V _{CC} Power Supply Voltage	5.75	6.0	6.25	V
V _{PP}	V _{PP} Power Supply Voltage	12.0	12.5	13.0	V

DC and OPERATING CHARACTERISTICS (T_a=25±5°C, V_{CC}=6V±0.25V, V_{PP}=12.5V±0.5V)

SYMBOL	PARAMETER	TEST CONDITION	MIN.	TYP.	MAX.	UNIT
I _{LI}	Input Current	V _{IN} =0 ~ V _{CC}	-	-	±10	μA
V _{OH}	Output High Voltage	I _{OH} =-400μA	2.4	-	-	V
V _{OL}	Output Low Voltage	I _{OL} =2.1mA	-	-	0.4	V
I _{CC}	V _{CC} Supply Current	-	-	-	30	mA
I _{PP2}	V _{PP} Supply Current	V _{PP} =13.0V	-	-	50	mA

AC PROGRAMMING CHARACTERISTICS (T_a=25±5°C, V_{CC}=6V±0.25V, V_{PP}=12.5V±0.5V)

SYMBOL	PARAMETER	TEST CONDITION	MIN.	TYP.	MAX.	UNIT
t _{AS}	Address Setup Time	-	2	-	-	μs
t _{AH}	Address Hold Time	-	2	-	-	μs
t _{OES}	\overline{OE}/V_{PP} Setup Time	-	2	-	-	μs
t _{OEH}	\overline{OE}/V_{PP} Hold Time	-	2	-	-	μs
t _{PRT}	\overline{OE}/V_{PP} Pulse Rise Time	-	50	-	-	ns
t _{DS}	Data Setup Time	-	2	-	-	μs
t _{DH}	Data Hold Time	-	2	-	-	μs
t _{VR}	\overline{OE}/V_{PP} Recovery Time	-	2	-	-	μs
t _{VCS}	V _{CC} Setup Time	-	2	-	-	μs
t _{PW}	Initial Program Pulse Width	$\overline{CE}=V_{IL}$, $\overline{OE}/V_{PP}=V_{PP}$	0.95	1.0	1.05	ms
t _{OPW}	Overprogram Pulse Width	Note 1	2.85	3.0	78.75	ms
t _{DV}	Data Valid from \overline{CE}	$\overline{OE}/V_{PP}=V_{IL}$	-	-	1	μs
t _{DF}	\overline{CE} to Output in High-Z	$\overline{OE}/V_{PP}=V_{IL}$	-	-	130	ns

AC TEST CONDITIONS

- Output Load : 1 TTL Gate and C_L (100pF)
- Input Pulse Rise and Fall Times : 10ns Max.
- Input Pulse Levels : 0.45V ~ 2.4V
- Timing Measurement Reference Level: Input 0.8V and 2.0V, Output 0.8V and 2.0V

Note 1: The length of the overprogram pulse may vary as a function of the counter value X.

HIGH SPEED PROGRAM MODE II

DC RECOMMENDED OPERATING CONDITIONS

SYMBOL	PARAMETER	MIN.	TYP.	MAX.	UNIT
V _{IH}	Input High Voltage	2.2	-	V _{CC} +1.0	V
V _{IL}	Input Low Voltage	-0.3	-	0.8	V
V _{CC}	V _{CC} Power Supply Voltage	6.0	6.25	6.5	V
V _{PP}	V _{PP} Power Supply Voltage	12.5	12.75	13.0	V

DC and OPERATING CHARACTERISTICS (T_a=25±5°C, V_{CC}=6.25V±0.25V, V_{PP}=12.75V±0.25V)

SYMBOL	PARAMETER		MIN.	TYP.	MAX.	UNIT
I _{LI}	Input Current	V _{IN} =0 ~ V _{CC}	-	-	±10	μA
V _{OH}	Output High Voltage	V _{OH} =-400μA	2.4	-	-	V
V _{OL}	Output Low Voltage	I _{OL} =2.1mA	-	-	0.4	V
I _{CC}	V _{CC} Supply Current	-	-	-	30	mA
I _{PP2}	V _{PP} Supply Current	V _{PP} =13.0V	-	-	50	mA

AC PROGRAMMING CHARACTERISTICS (T_a=25±5°C, V_{CC}=6.25V±0.25V, V_{PP}=12.75V±0.25V)

SYMBOL	PARAMETER	TEST CONDITION	MIN.	TYP.	MAX.	UNIT
t _{AS}	Address Setup Time	-	2	-	-	μs
t _{AH}	Address Hold Time	-	2	-	-	μs
t _{OES}	\overline{OE}/V_{PP} Setup Time	-	2	-	-	μs
t _{OEH}	\overline{OE}/V_{PP} Hold Time	-	2	-	-	μs
t _{PRI}	\overline{OE}/V_{PP} Pulse Rise Time	-	50	-	-	ns
t _{DS}	Data Setup Time	-	2	-	-	μs
t _{DH}	Data Hold Time	-	2	-	-	μs
t _{VR}	\overline{OE}/V_{PP} Recovery Time	-	2	-	-	μs
t _{VCS}	V _{CC} Setup Time	-	2	-	-	μs
t _{PW}	Program Pulse Width	$\overline{CE}=V_{IL}, \overline{OE}/V_{PP}=V_{PP}$	0.095	0.1	0.105	ms
t _{DV}	Data Valid from \overline{CE}	$\overline{OE}/V_{PP}=V_{IL}$	-	-	1	μs
t _{DF}	\overline{CE} to Output in High-Z	$\overline{OE}/V_{PP}=V_{IL}$	-	-	130	ns

AC TEST CONDITIONS

- Output Load : 1 TTL Gate and C_L (100pF)
- Input Pulse Rise and Fall Times : 10ns Max.
- Input Pulse Levels : 0.45V ~ 2.4V
- Timing Measurement Reference Level: Input 0.8V and 2.2V, Output 0.8V and 2.0V

TC54512AP-15, TC54512AP-20 TC54512AF-15, TC54512AF-20

TIMING WAVEFORMS (PROGRAM)

HIGH SPEED PROGRAMMING MODE I ($V_{CC}=6V\pm 0.25V$, $V_{PP}=12.5V\pm 0.5V$)
 HIGH SPEED PROGRAMMING MODE II ($V_{CC}=6.25V\pm 0.25V$, $V_{PP}=12.75V\pm 0.25V$)

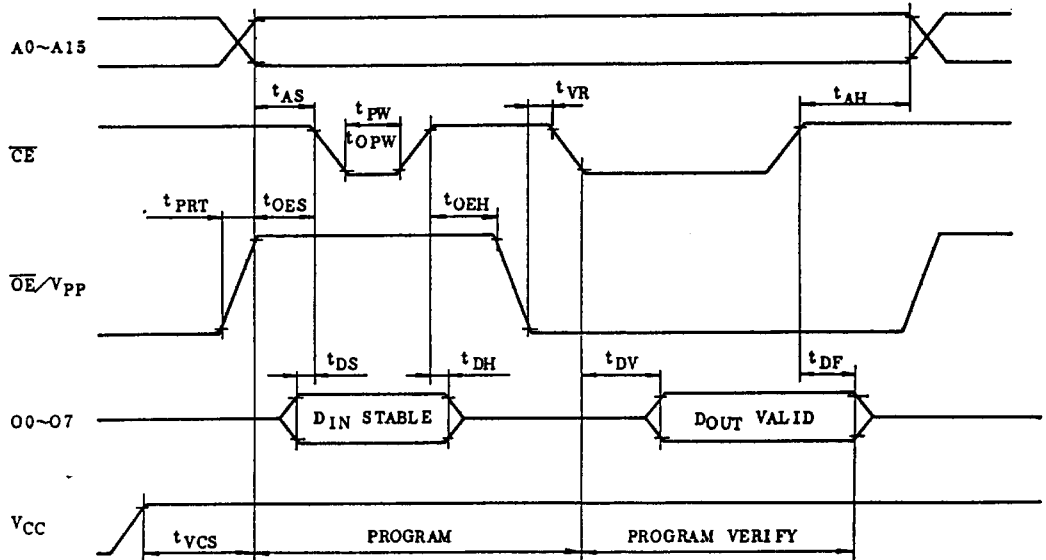

- Note 1. V_{CC} must be applied simultaneously or before V_{pp} and cut off simultaneously or after V_{pp} .
2. Removing the device from socket and setting the device in socket with $V_{pp}=12.5\pm 0.5V$ or $V_{pp}=12.75\pm 0.25V$ may cause permanent damage to the device.
3. The V_{pp} supply voltage is permitted up to 14V for program operation. So the voltage over 14V should not be applied to the V_{pp} terminal. When the switching pulse voltage is applied to the V_{pp} terminal, the overshoot voltage of its pulse should not be exceeded 14V.

OPERATION INFORMATION

The TC54512AP/AF's six operation modes are listed in the following table.
 Mode selection can be achieved by applying TTL level signal to all inputs.

MODE		PIN NAMES (NUMBER)	\overline{CE} (20)	\overline{OE} (22)	V _{pp} (1)	V _{CC} (28)	00 ~ 07 (11 ~ 13, 15 ~ 19)	POWER
Read Operation (T _a =-40 ~ 85°C)	Read		L	L	5V	5V	Data Out	Active
	Output Deselect	*	H	High Impedance				
	Standby	H	*	High Impedance			Standby	
Program Operation (T _a =25±5°C)	Program		L	H	12.5V ¹⁾	6V ¹⁾	Data In	Active
	Program Inhibit	H	H	High Impedance				
	Program Verify	*	L	12.75V ²⁾	6.25V ²⁾	Data Out		

Note: H; V_{IH}, L; V_{IL}, *: V_{IH} or V_{IL}.
 1); HIGH SPEED PROGRAM MODE I
 2); HIGH SPEED PROGRAM MODE II

READ MODE

The TC54512AP/AF has two control functions. The chip enable (\overline{CE}) controls the operation power and should be used for device selection. The output enable (\overline{OE}) control the output buffers, independent of device selection. Assuming that $\overline{CE}=\overline{OE}=V_{IL}$, the output data is valid at the outputs after address access time from stabilizing of all addresses. The \overline{CE} to output valid (t_{CE}) is equal to the address access time (t_{ACC}). Assuming that $\overline{CE}=V_{IL}$ and all addresses are valid, the output data is valid at the outputs after t_{OE} from the falling edge of \overline{OE} .

TC54512AP-15, TC54512AP-20

TC54512AF-15, TC54512AF-20

OUTPUT DESELECT MODE

Assuming that $\overline{CE}=V_{IH}$ or $\overline{OE}=V_{IH}$, the outputs will be in a high impedance state. So two or more TC54512AP/AF's can be connected together on a common bus line. When \overline{CE} is decode for device selection, all deselected devices are in low power standby mode.

STANDBY MODE

The TC54512AP/AF has a low power standby mode controlled by the CE signal. By applying a high level to the \overline{CE} input, the TC54512AP/AF is placed in the standby mode which reduce the operating current to 100 μ A by applying MOS-high level (V_{CC}) and then the outputs are in a high impedance state, independent of the \overline{OE} inputs.

PROGRAM MODE

Initially, when received by customers, all bits of the TC54512AP/AF are in the "1" state which is erased state. Therefore the program operation is to introduce "0's" data into the desired bit locations by electrically programming. The TC54512AP/AF is in the programming mode when the \overline{OE}/V_{pp} input is at 12.5V or 12.75V and \overline{CE} is at TTL-Low level. The TC54512AP/AF can be programmed any location at any time either individually, sequentially, or at random.

PROGRAM VERIFY MODE

The verify mode is to check that desired data is correctly programmed on the programmed bits. The verify is accomplished with \overline{OE}/V_{pp} at V_{IL} and \overline{CE} at V_{IL} .

PROGRAM INHIBIT MODE

Under the condition that the program voltage (+12.5V or +12.75V) is applied to V_{pp} terminal, a high level \overline{CE} input inhibits the TC54512AP/AF from being programmed. Programming of two or more TC54512AP/AF's in parallel with different data is easily accomplished. That is, all inputs except for CE may be commonly connected, and a TTL low level program pulse is applied to the \overline{CE} of the desired device only and TTL high level signal is applied to the other devices.

HIGH SPEED PROGRAM MODE I

This high speed programming mode I is performed at $V_{CC}=6.0V$ and $\overline{OE}/V_{pp}=12.5V$. The programming is achieved by applying a single TTL low level 1ms pulse to the \overline{CE} input after addresses and data are stable. Then the programmed data is verified by using Program Verify Mode.

If the programmed data is not correct, another program pulse of 1ms is applied and then the programmed data is verified. This should be repeated until the program operates correctly (max. 25 times).

After correctly programming the selected address, the additional program pulse with 3 times that needed for initial programming is applied.

When programming has been completed, the data in all addresses should be verified with $V_{CC}=5V$.

HIGH SPEED PROGRAM MODE II

The program time can be greatly decreased by using this high speed programming mode II. This high speed programming mode II is performed at $V_{CC}=6.25V$ and $\overline{OE}/V_{pp}=12.75V$. The programming is achieved by applying a single TTL low level 0.1ms pulse to the \overline{CE} input after addresses and data are stable. Then the programmed data is verified by using Program Verify Mode.

If the programmed data is not correct, another program pulse of 0.1ms is applied and then the programmed data is verified. This should be repeated until the program operates correctly (max. 25 times).

When programming has been completed, the data in all addresses should be verified with $V_{CC}=5V$.

TC54512AP-15, TC54512AP-20
 TC54512AF-15, TC54512AF-20

HIGH SPEED PROGRAM MODE I

FLOW CHART

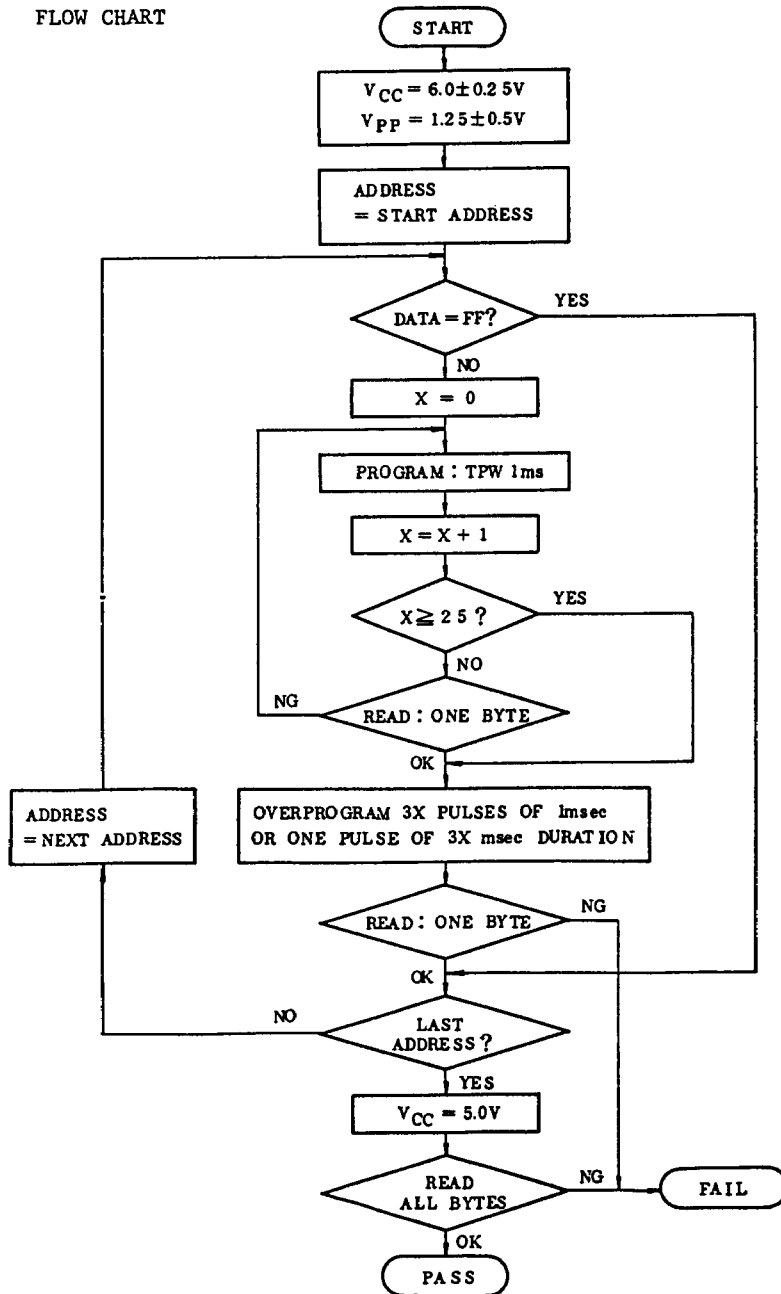

HIGH SPEED PROGRAM MODE II

FLOW CHART

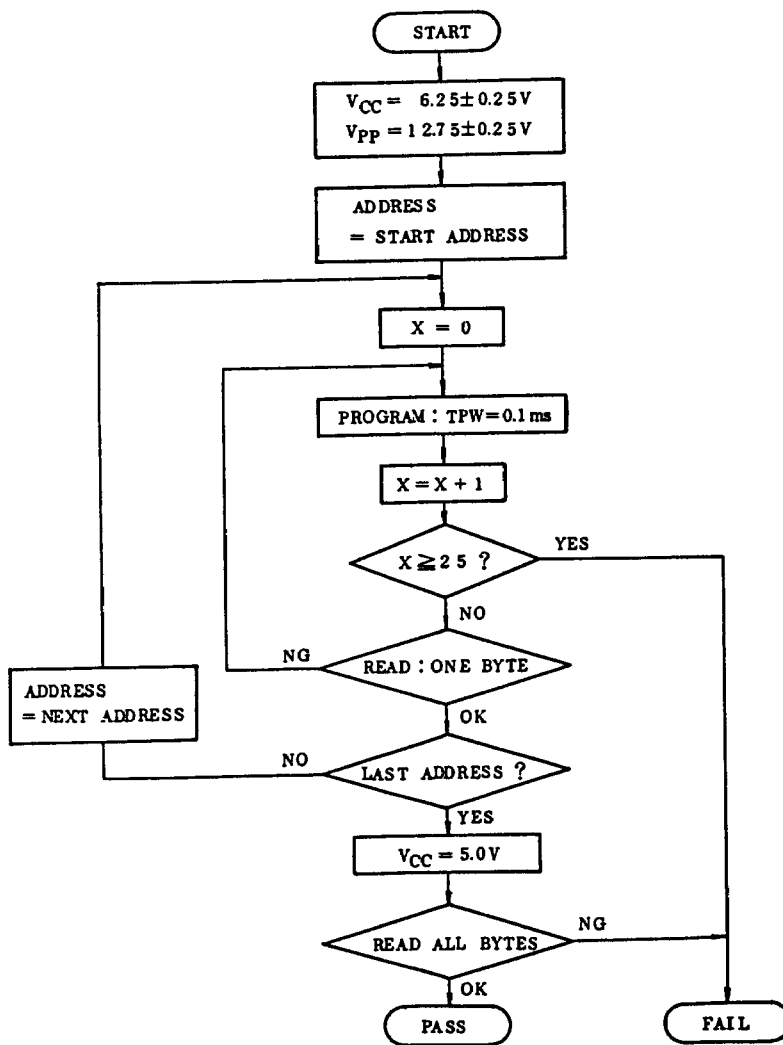

TC54512AP-15, TC54512AP-20 TC54512AF-15, TC54512AF-20

ELECTRIC SIGNATURE MODE

Electric signature mode allows to read out a code from TC54512AP/AF which identifies its manufacturer and device type.

The programming equipment may reads out manufacturer code and device code from TC54512AP/AF by using this mode before program operation and automatically set program voltage (V_{pp}) and algorithm.

Electric Signature mode is set up when 12V is applied to address line A9 and the rest of address lines is set to V_{IL} in read operation. Data output in this condition is manufacturer code. Device code is identified when address A0 is set to V_{IH} . These two codes possess an odd parity with the parity bit of MSB (07).

The following table shows electric signature of TC54512AP/AF.

SIGNATURE \ PINS	A0 (10)	07 (19)	06 (18)	05 (17)	04 (16)	03 (15)	02 (13)	01 (12)	00 (11)	HEX. DATA
Manufacture Code	V_{IL}	1	0	0	1	1	0	0	0	98
Device Code	V_{IH}	1	0	0	0	0	1	0	1	85

Notes: A9=12V±0.5V

A1 ~ A8, A10 ~ A15, \overline{CE} , \overline{OE} = V_{IL}

TC54512AP-15, TC54512AP-20
 TC54512AF-15, TC54512AF-20

OUTLINE DRAWINGS (TC54512AP) DIP28-P-600

Unit in mm

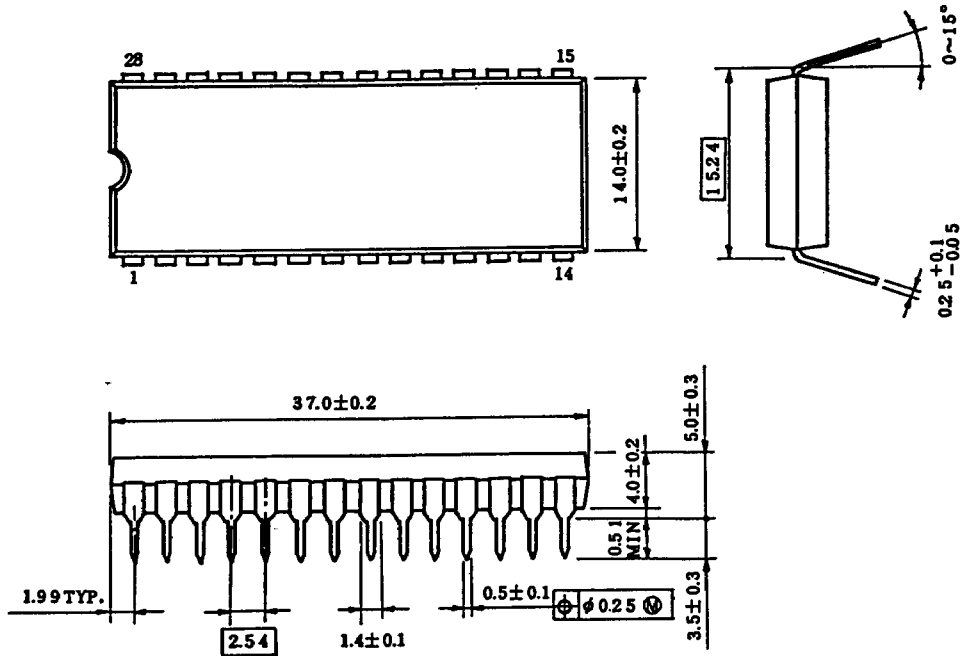

Note: Package width and length do not include mold protrusion,
 allowable mold protrusion is 0.15mm.

TC54512AP-15, TC54512AP-20
 TC54512AF-15, TC54512AF-20

OUTLINE DRAWINGS (TC54512AF) SOP28-P-450

Unit in mm

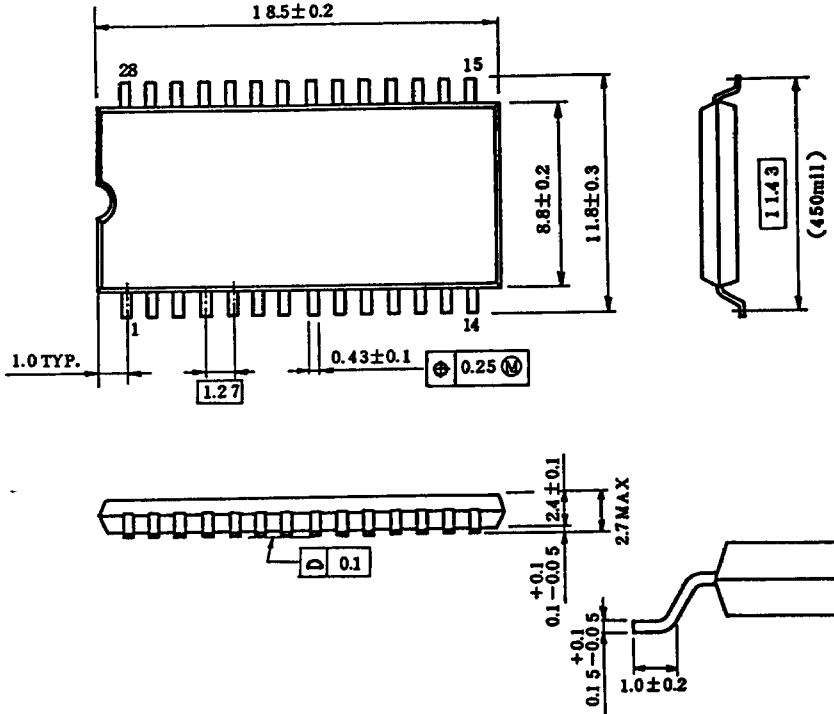

Note: Package width and length do not include mold protrusion, allowable mold protrusion is 0.15mm.