

MOS Memories

FUJITSU

■ **MB81416-10, MB81416-12, MB81416-15**
 NMOS 65,536-Bit Dynamic
 Random Access Memory

Description

The Fujitsu MB81416 is a fully decoded, dynamic NMOS random access memory organized as 16384 words by 4-bits. The design is optimized for high speed, high performance applications such as mainframe memory, buffer memory, peripheral storage and environments where low power dissipation and compact layout are required.

Multiplexed row and column address inputs permit the MB81416 to be housed in a standard 18-pin DIP that is compatible with the JEDEC approved pinout. Greater refresh versatility is provided by a new $\overline{\text{CAS}}$ before $\overline{\text{RAS}}$ on-chip refresh capability. The MB81416 also features "page mode" which allows high speed random access of up to 64 nibble wide words within the same row address.

The MB81416 is fabricated using silicon gate NMOS and Fujitsu's advanced Double-Layer Polysilicon process. This process, coupled with single-transistor memory storage cells, permits maximum circuit density and minimal chip size. Dynamic circuitry is employed in the design, including the sense amplifiers.

Clock timing requirements are non-critical, and the power supply tolerance is very wide. All inputs and outputs are TTL compatible.

Features

- Organized as 16384 words by 4-bits
- Row Access Time/Cycle Time:
 MB81416-10 100nsec max/200 min.
 MB81416-12 120nsec max/230 min.
 MB81416-15 150nsec max/260 min.
- Low Active Power ($t_{RC} = \text{min}$)
 MB81416-10 303mW (max.)
 MB81416-12 275mW (max.)
 MB81416-15 248mW (max.)
 All devices 25mW standby
- Single +5V $\pm 10\%$ Power Supply
- $\overline{\text{CAS}}$ before $\overline{\text{RAS}}$ Refresh
- $\overline{\text{RAS}}$ Only Refresh
- Hidden $\overline{\text{CAS}}$ before $\overline{\text{RAS}}$ Refresh
- 2ms/128 cycle Refresh ($A_0 - A_6$)
- Read-Modify-Write Capability
- Page Mode Capability for faster access
- Output unlatched at cycle end
- Early Write or Output Enable controls output buffer impedance
- On Chip Address and Data-In latches
- Standard 18-pin DIP
- All Inputs TTL Compatible, low capacitive load
- Three-State TTL Compatible Outputs
- On-chip Substrate Bias Generator

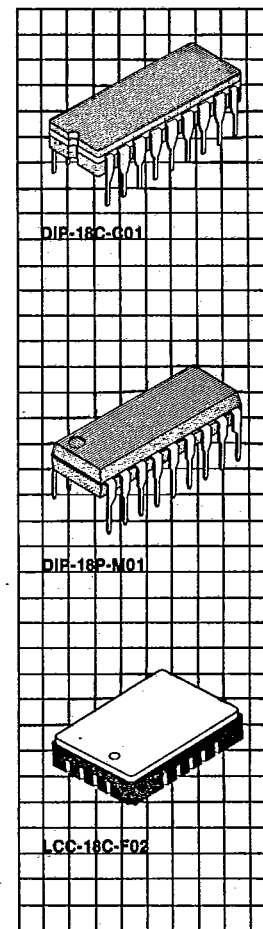

NOTE: The following IEEE Std. 682-1980 Symbols are used in this data sheet: $\overline{\text{DQ}}$ = Data I/O, $\overline{\text{G}}$ = Output Enable and $\overline{\text{W}}$ = Write Enable.

MB81416-10
 MB81416-12
 MB81416-15

MB81416 Block Diagram and Pin Configurations

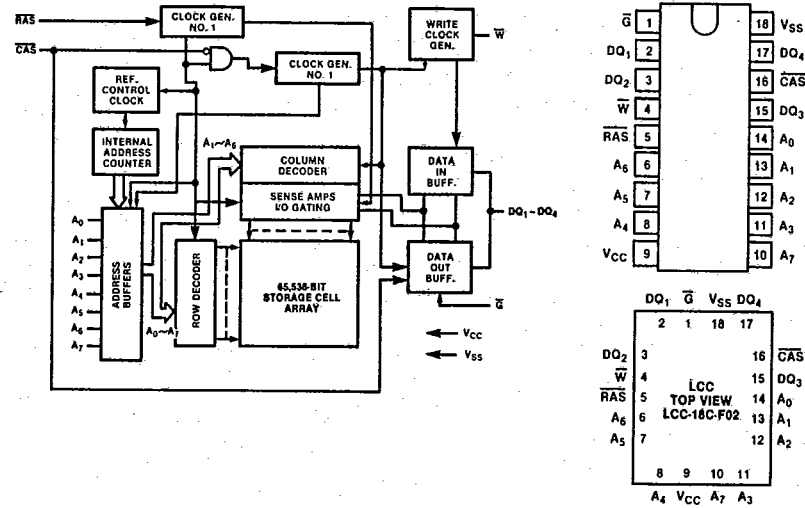

Absolute Maximum Ratings
 (See Note)

Rating	Symbol	Value	Unit
Voltage on any pin relative to V_{SS}	V_{IN}, V_{OUT}	-1 to +7	V
Voltage on V_{CC} supply relative to V_{SS}	V_{CC}	-1 to +7	V
Storage Temperature	T_{STG}	-55 to +150 Ceramic -55 to +125 Plastic	°C
Power Dissipation	P_D	1.0	W
Short Circuit Output Current	—	50	mA

NOTE: Permanent device damage may occur if ABSOLUTE MAXIMUM RATINGS are exceeded. Functional operation should be restricted to the conditions as detailed in the operations sections of this data sheet. Exposure to absolute maximum rating conditions for extended periods may affect device reliability. This device contains circuitry to protect the inputs against damage due to high static voltages or electric fields. However, it is advised that normal precautions be taken to avoid application of any voltage higher than maximum rated voltages to this high impedance circuit.

Capacitance
 ($T_A = 25^\circ\text{C}$)

Parameter	Symbol	Typ	Max	Unit
Input Capacitance $A_0 \sim A_7$	C_{IN1}	—	5	pF
Input Capacitance RAS, CAS, W, \bar{G}	C_{IN2}	—	8	pF
Output Capacitance $DQ_1 \sim DQ_4$	C_D	—	7	pF

Recommended Operating Conditions
 (Referenced to V_{SS})

Parameter	Symbol	Min	Typ	Max	Unit	Operating Temperature
Supply Voltage	V_{CC}	4.5	5.0	5.5	V	0°C to +70°C
	V_{SS}	0	0	0	V	
Input High Voltage	V_{IH}	2.4	—	6.5	V	
Input Low Voltage, all inputs except DQ	V_{IL}	-2.0	—	0.8	V	
Input Low Voltage, DQ	V_{ILD}^*	-1.0	—	0.8	V	

*The device will withstand undershoots to the -2.0V level with a maximum pulse width the 20ns at the -1.5V level.

FUJITSU

MB81416-10
 MB81416-12
 MB81416-15

DC Characteristics
 (Recommended operating conditions unless otherwise noted.)

Parameter	Symbol	Min	Max	Unit
OPERATING CURRENT*				
Average power supply current (RAS, CAS cycling; $t_{RC} = \text{min}$)	I_{CC1}		55	mA
			50	
			45	
STANDBY CURRENT				
Power supply current ($\overline{\text{RAS}} = \overline{\text{CAS}} = V_{IH}$)	I_{CC2}		4.5	mA
REFRESH CURRENT1*				
Average power supply current (CAS = V_{IH} , RAS cycling; $t_{RO} = \text{min}$)	I_{CC3}		38	mA
			35	
			32	
PAGE MODE CURRENT				
Average power supply current (RAS = V_{IL} , $\overline{\text{CAS}}$ cycling; $t_{PC} = \text{min}$)	I_{CC4}		38	mA
			35	
			32	
REFRESH CURRENT 2*				
Average power supply current (RAS cycling, $\overline{\text{CAS}}$ before $\overline{\text{RAS}}$)	I_{CC5}		42	mA
			38	
			35	
INPUT LEAKAGE CURRENT				
Input leakage current, any input ($0 \leq V_{IN} \leq 5.5V$, $V_{CC} = 5.5V$, $V_{SS} = 0V$, all other pins not under test = $0V$)	I_{IL}	-10	10	μA
OUTPUT LEAKAGE CURRENT (Data out is disabled, $0V \leq V_{OUT} \leq 5.5V$)	I_{OL}	-10	10	μA
OUTPUT LEVELS				
Output high voltage ($I_{OH} = -5mA$)	V_{OH}	2.4		V
Output low voltage ($I_{OL} = 4.2mA$)	V_{OL}		0.4	

Note*: I_{CC} is dependent on output loading and cycle rates. Specified values are obtained with the output open. I_{CC} is dependent on input low voltage level V_{ILD} . $V_{ILD} > -0.5V$.

MB81416-10
 MB81416-12
 MB81416-15

AC Characteristics
 (Recommended operating conditions unless otherwise noted.)

Parameter	Notes	Symbol Alternate	*Standard	MB81416-10		MB81416-12		MB81416-15		Unit
				Min	Max	Min	Max	Min	Max	
Time between Refresh		t _{REF}	TRVRV	—	2	—	2	—	2	ms
Random Read/Write Cycle Time		t _{RC}	TRELREL	200	—	230	—	260	—	ns
Read-Write Cycle Time		t _{RWC}	TRELREL	290	—	330	—	375	—	ns
Access Time from RAS	(4), (6)	t _{RAC}	TRELQV	—	100	—	120	—	150	ns
Access Time from CAS	(5), (6)	t _{CAC}	TCELQV	—	50	—	60	—	75	ns
Output Buffer Turn Off Delay		t _{OFF}	TCEHQZ	0	30	0	35	0	40	ns
Transition Time		t _T	TT	3	50	3	50	3	50	ns
RAS Precharge Time		t _{RP}	TREHREL	90	—	100	—	100	—	ns
RAS Pulse Width		t _{RAS}	TRELREH	100	10000	120	10000	150	10000	ns
RAS Hold Time		t _{RSH}	TCELREH	50	—	60	—	75	—	ns
CAS Precharge Time (Page Mode only)		t _{CP}	TCEHCEL	45	—	50	—	60	—	ns
CAS Precharge Time (All cycles except page mode)		t _{CPN}	TCEHCEL	40	—	45	—	55	—	ns
CAS Pulse Width		t _{CAS}	TCELCEH	50	10000	60	10000	75	10000	ns
CAS Hold Time		t _{CSH}	TRELCEH	100	—	120	—	150	—	ns
RAS to CAS Delay Time	(4), (7)	t _{RCD}	TRELCEL	20	50	20	60	25	75	ns
CAS to RAS Set Up Time		t _{CBS}	TCEHREL	20	—	25	—	30	—	ns
Row Address Set Up Time		t _{ASR}	TAVREL	0	—	0	—	0	—	ns
Row Address Hold Time		t _{RAH}	TRELAX	10	—	10	—	15	—	ns
Column Address Set Up Time		t _{ASC}	TAVCEL	0	—	0	—	0	—	ns
Column Address Hold Time		t _{CAH}	TCELAX	15	—	15	—	20	—	ns
Read Command Set Up Time		t _{RCS}	TWHCEL	0	—	0	—	0	—	ns
Read Command Hold Time Referenced to RAS	(9)	t _{RRH}	TREH WX	20	—	20	—	20	—	ns
Read Command Hold Time Referenced to CAS	(9)	t _{RCH}	TCEH WX	0	—	0	—	0	—	ns
Write Command Set Up Time		t _{WCS}	TWLCEL	-5	—	-5	—	-5	—	ns
Write Command Hold Time		t _{WCH}	TCELWH	20	—	25	—	30	—	ns
Write Command Pulse Width		t _{WP}	TWLWH	20	—	25	—	30	—	ns
Write Command to RAS Lead Time		t _{RWL}	TWLREH	45	—	50	—	60	—	ns
Write Command to CAS Lead Time		t _{CWL}	TWLCEH	45	—	50	—	60	—	ns
Data In Set Up Time		t _{DS}	TDVCEL	0	—	0	—	0	—	ns
Data In Hold Time		t _{DH}	TCELDX	20	—	25	—	30	—	ns
CAS to W Delay	(8)	t _{CWD}	TCELWL	85	—	100	—	120	—	ns
RAS to W Delay	(8)	t _{RWD}	TRELWL	135	—	160	—	195	—	ns
Access Time from G		t _{OE A}	TGLQV	—	25	—	30	—	40	ns
G to Data In Delay Time		t _{OED}	TGH DV	30	—	35	—	40	—	ns
G Hold Time Referenced to W		t _{OE H}	TWLGL	0	—	0	—	0	—	ns
Output Buffer Turn Off Delay from G		t _{OE Z}	TGHQZ	0	30	0	35	0	40	ns
Page Mode Cycle Time		t _{PC}	TCELCEL	105	—	120	—	145	—	ns
Page Mode Read-Write Cycle Time		t _{PRWC}	TCEHCEH	180	—	205	—	240	—	ns
CAS Set Up Time Referenced to RAS (CAS before RAS Refresh)		t _{FCS}	TCELREL	20	—	25	—	30	—	ns
CAS Hold Time Referenced to RAS (CAS before RAS Refresh)		t _{FCH}	TRELCEH	20	—	25	—	30	—	ns
RAS Precharge to CAS Active Time		t _{RPC}	TREHCEL	20	—	20	—	20	—	ns
Refresh Counter Test RAS Pulse Width	(10)	t _{TRAS}	TRELREH	280	—	325	—	390	—	ns
Refresh Counter Test Cycle Time	(10)	t _{RTC}	TRELREL	380	—	435	—	500	—	ns
G to RAS Inactive Setup Time		t _{OES}	TGLREH	0	—	0	—	0	—	ns
Data In to CAS Delay Time	(11)	t _{DZC}	TDXCEL	0	—	0	—	0	—	ns
Data In to G Delay Time	(11)	t _{DZO}	TDXGL	0	—	0	—	0	—	ns
CAS Precharge Time (CAS before RAS cycle)		t _{CPR}	TCEHCEL	25	—	30	—	30	—	ns

Notes: See notes on next page.

*These symbols are described in IEEE Std. 662-1980: IEEE Standard Terminology for Semiconductor Memory.

FUJITSU

MB81416-10
 MB81416-12
 MB81416-15

AC Characteristics
 (Continued)

Notes:

1. An initial pause of 200µs is required after power up, followed by any 8 RAS cycles, before proper operation is achieved. If the internal refresh counter is to be effective, a minimum of 8 CAS-before-RAS initialization cycles instead of 8 RAS cycles are required.
2. AC measurements assume $t_T = 5ns$.
3. V_{IH} (min.) and V_{IL} (max.) are reference levels for measuring timing of input signals. Transition times are measured between V_{IH} (min.) and V_{IL} (max.).
4. t_{RCD} is specified as a reference point only. If $t_{RCD} \leq t_{RAC}$ (max.) the specified maximum value of t_{RAC} can be met. If $t_{RCD} > t_{RAC}$ (max.) then t_{RAC} is increased by the amount that t_{RCD} exceeds t_{RAC} (max.).
5. Assumes that $t_{RCD} \geq t_{RCD}$ (max.).
6. Measured with a load equivalent to 2 TTL loads and 100pF.
7. t_{RCD} (min.) = t_{RAH} (min.) + $2t_T$ + t_{ASO} (min.); $t_T = 5ns$.
8. t_{WCS} , t_{CWD} and t_{RWD} are non-restrictive operating parameters. They are included in the data sheet as electrical characteristics only. If $t_{WCS} \geq t_{WCS}$ (min.), the cycle is an early write cycle and the data out pin will remain open circuit (high impedance) throughout the entire cycle. If $t_{CWD} \geq t_{CWD}$ (min.) and $t_{RWD} \geq t_{RWD}$ (min.), the cycle is a read-write cycle and data out will contain data read from the selected cell. If neither of the above sets of conditions is satisfied, the condition of the data out is indeterminate.
9. Either t_{RRH} or t_{RCH} must be satisfied for a read cycle.
10. Refresh counter test cycle only.
11. Either t_{DZC} or t_{DZO} must be satisfied for all cycles.

Timing Diagrams

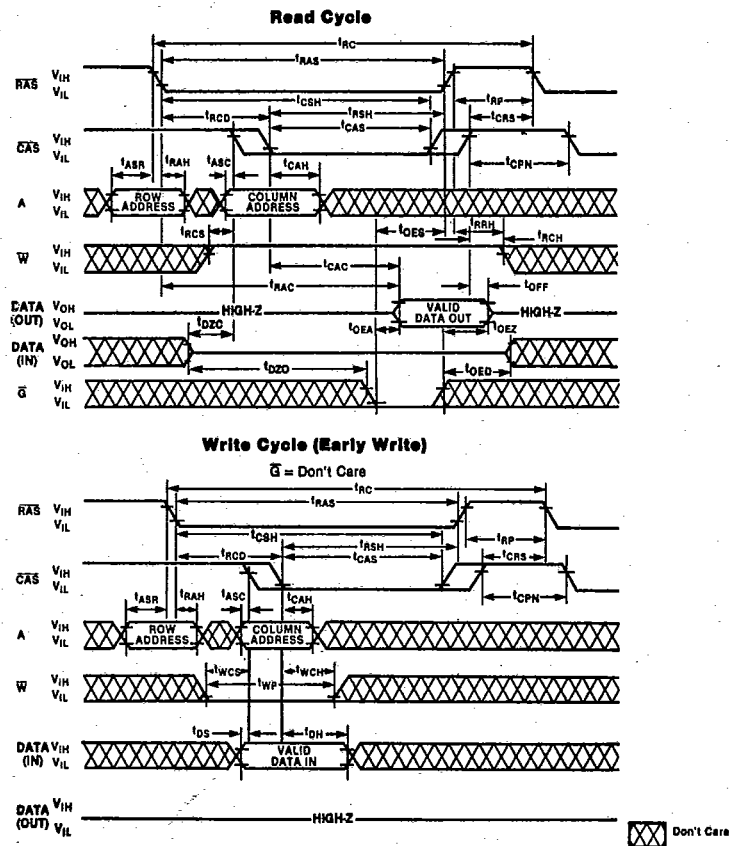

MB81416-10
 MB81416-12
 MB81416-15

Timing Diagrams
 (Continued)

Write Cycle
 (Output Enable Controlled)

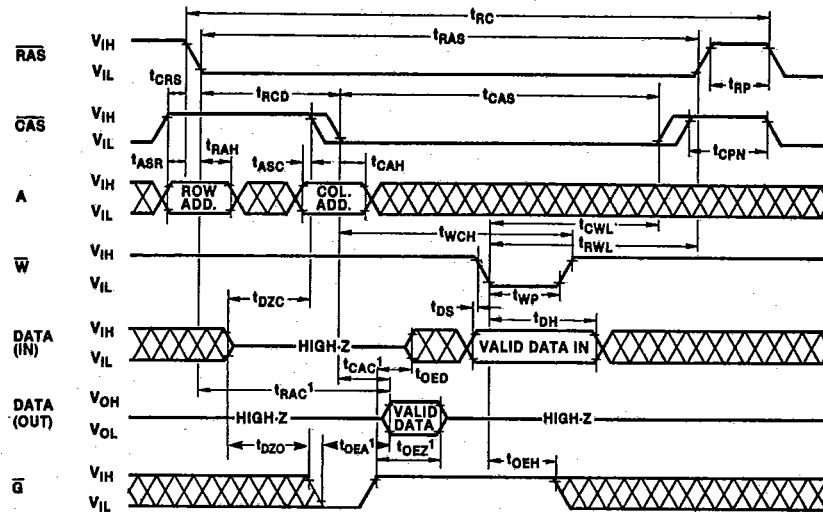

Note 1: When t_{CWD} is satisfied and \bar{G} is low (Delayed Write Cycle), the data out will be "VALID". But when t_{CWD} is not satisfied, the data out will be "INVALID".

Read-Write/Read-Modify-Write Cycle

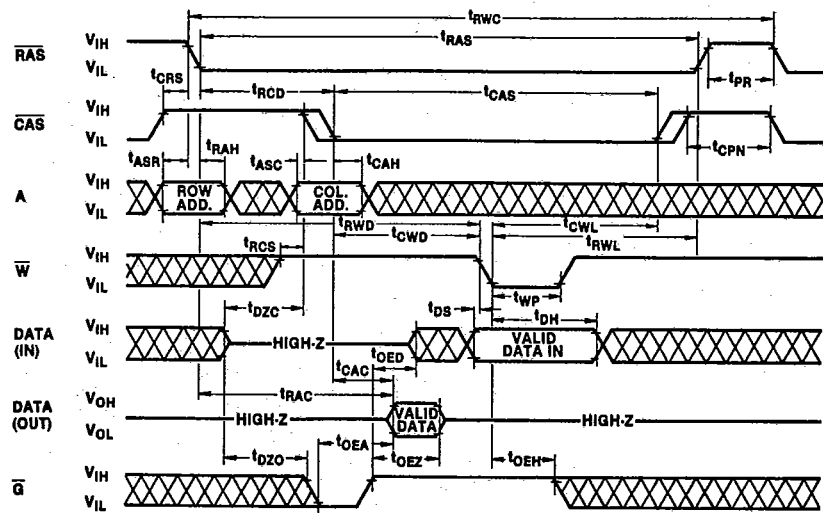

Don't Care

MS1416-10
 MS1416-12
 MS1416-15

Timing Diagrams
 (Continued)

Page Mode Read Cycle

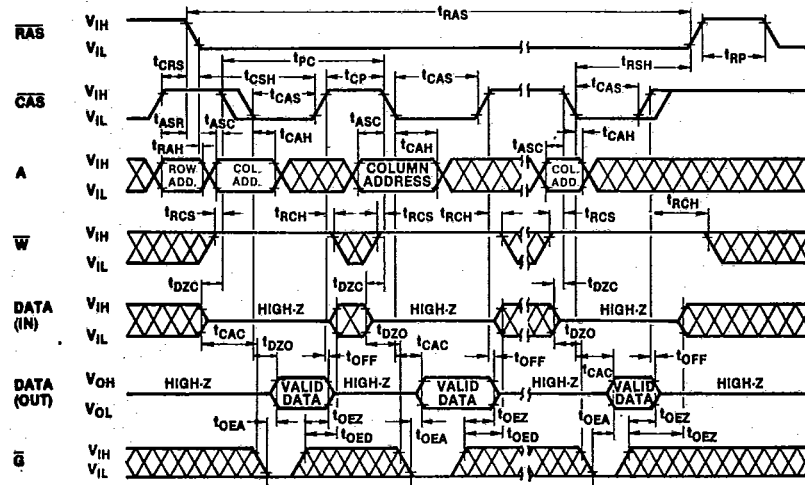

Page Mode Write Cycle

(G = Don't Care)

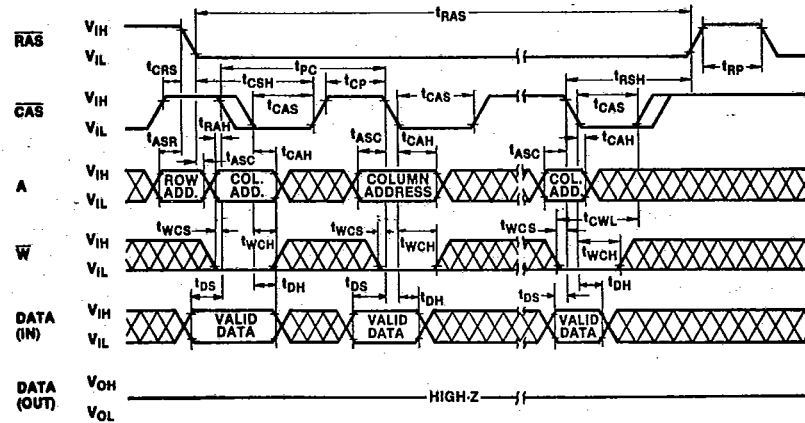

⊗ Don't Care

MB81416-10
 MB81416-12
 MB81416-15

Timing Diagrams
 (Continued)

Page Mode Read-Write Cycle

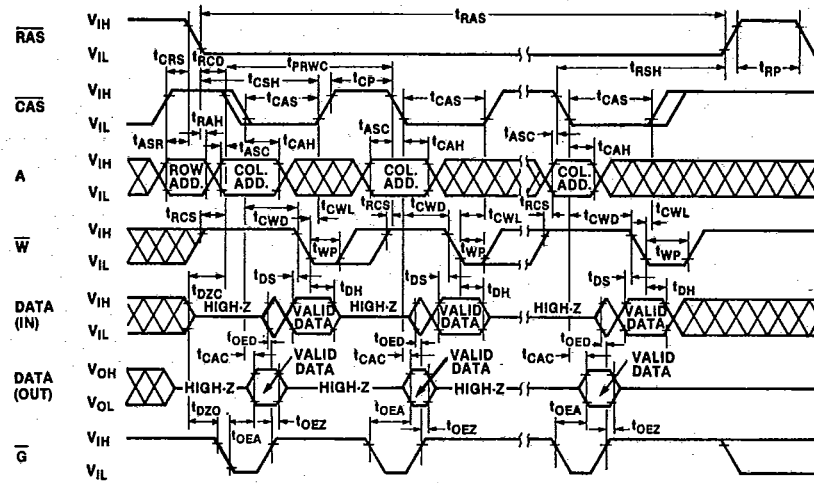

RAS Only Refresh Cycle

NOTE: CAS = V_{IH} ; A, W, G = Don't Care

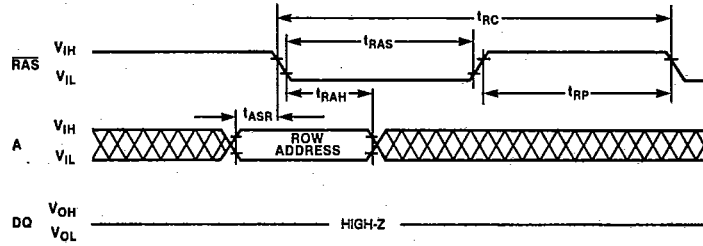

CAS-Before-RAS Refresh Cycle

NOTE: A, W, G = Don't Care

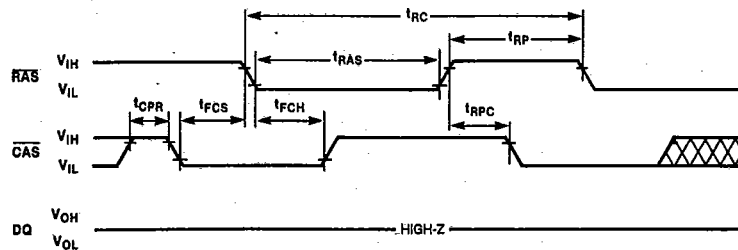

⊗ Don't Care

MB81416-10
 MB81416-12
 MB81416-15

Timing Diagrams
 (Continued)

Hidden Refresh Cycle

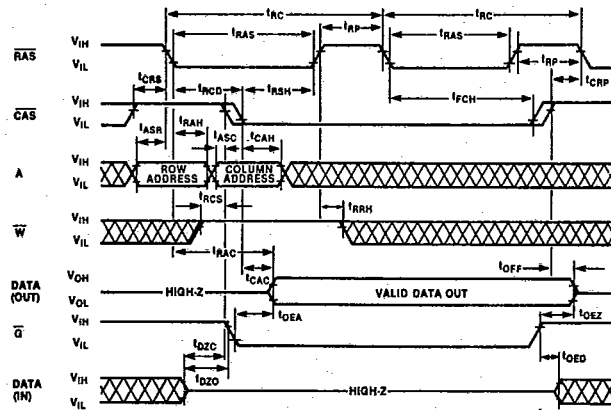

CAS-Before-RAS Refresh Counter Test Cycle

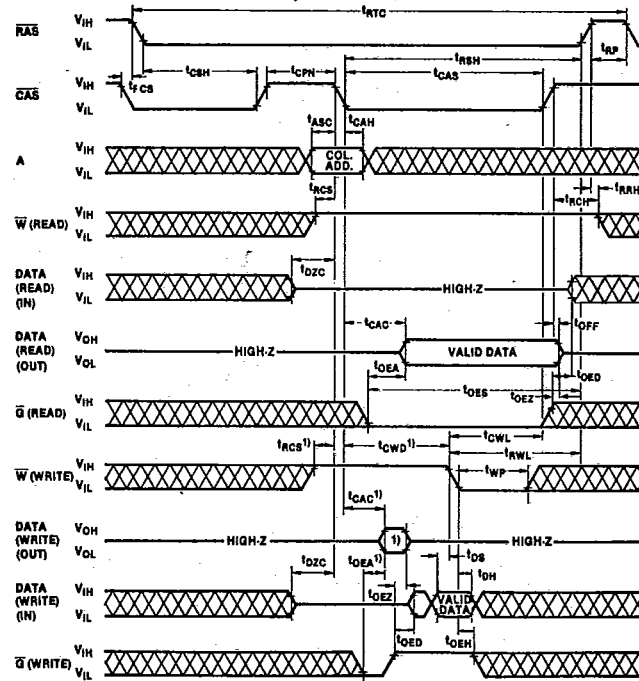

⊗ Don't Care

Note 1: When t_{CWD} is satisfied and \bar{G} is Low (Delayed-Write Cycle), the data out will be "VALID". But when t_{CWD} is not satisfied, the data out will be "INVALID".

MB81416-10
 MB81416-12
 MB81416-15

Description

Address Inputs

A total of 14 binary input address bits are needed to decode any one of 16,384 nibble wide words from the MB81416's 65,536 memory cells. Addressing a Random 4-bit word is initiated by establishing 8 row address bits on the address input pins, (A_0 through A_7), and after they are stable, latching these address bits with the falling edge of the Row Address Strobe (\overline{RAS}). Then 6 column address bits are established on the address input pins A_1 through A_6 . After the addresses are stable, they are latched with the falling edge of the Column Address Strobe (\overline{CAS}). Address timing is made non-critical by the MB81416's "gated \overline{CAS} " circuitry which automatically inhibits \overline{CAS} until the Row Address Hold time (t_{RAH}) has been satisfied and the address inputs have changed from row to column addresses.

Data Input/Output

The MB81416 has 4 common I/O pins (DQ_1 , DQ_2 , DQ_3 , and DQ_4). Read or write modes are selected with the write enable pin (\overline{W}). An output enable pin (\overline{G}) controls the state of the output buffers making delayed write and read-modify-write cycles possible. The DQ pins provide TTL compatible inputs and three-state TTL compatible outputs with a fan-out of two standard TTL loads. Data-out has the same polarity as data-in.

Write Enable

The read mode or write modes are determined by the state of the write enable pin (\overline{W}). A logic high on \overline{W} selects the read mode and a logic low on \overline{W} selects the write mode. When \overline{W} is high (read mode), the data inputs are disabled. If \overline{W} goes low and satisfies the write command set-up time (t_{WCS}) before \overline{CAS} goes low, the data outputs will remain in the high-impedance state for the duration of the cycle. This allows a write cycle to occur regardless

of the state of the output enable (\overline{G}).

Output Enable

The output buffers are controlled by both \overline{CAS} and output enable (\overline{G}). If either \overline{CAS} or \overline{G} are high the output buffers are in the high impedance state. During a read or read-modify-write cycle if both \overline{CAS} and \overline{G} are low, the output buffers are enabled. During an early write cycle \overline{G} has no effect on the output buffers.

Data Inputs

Data may be written into the MB81416 during a write or read-modify-write cycle. The last falling edge of \overline{CAS} or \overline{W} , strobes the data into the 4 on-chip data latches. In an early-write cycle, \overline{W} is brought low prior to \overline{CAS} , and the data is strobed in by \overline{CAS} with both the set-up time (t_{DS}) and hold time (t_{DH}) referenced to the falling edge of \overline{CAS} . The outputs are in the high impedance state regardless of \overline{G} 's state. In a delayed write or a read-modify-write cycle, \overline{W} is brought low after \overline{CAS} , data is strobed-in by \overline{W} , and set-up and hold times are referenced to \overline{W} . To avoid buss contention on I/O pins, it is necessary during a delayed write or a read-modify-write cycle for \overline{G} to be high prior to data input so that the output buffers are in the high impedance state when data is being written.

Data Outputs

Data can be read from the MB81416 with either a read or a read-modify-write cycle. These cycles begin with the outputs in the high impedance state. The outputs contain active, valid data only after both \overline{CAS} and \overline{G} have been brought low and have satisfied the minimum access time from \overline{RAS} (t_{RAC}) and the minimum access time from the output enable t_{OED} . Outputs contain valid data as long as both \overline{CAS} and \overline{G} are held low. They return to the high impedance state when either \overline{CAS} or \overline{G} go high.

\overline{RAS} -Only Refresh

The MB81416's dynamic memory cells may be refreshed by performing any memory cycle at each of the 128 row addresses (A_0 through A_7) at least every 2 milliseconds. When a row is accessed all bits in the row are refreshed. During refresh, A_7 (Pin 10) is not used and either V_{IH} or V_{IL} may be applied to this pin.

\overline{RAS} -only Refresh is a simplified cycle that consists of strobing a row address with \overline{RAS} while \overline{CAS} remains high. During a \overline{RAS} -only Refresh cycle, \overline{CAS} is high and the output buffers are in the high impedance state. Strobing each of the 128 row addresses (A_0 through A_7) with \overline{RAS} will refresh all 65,536 memory cells in the MB81416. \overline{RAS} -only Refresh results in a substantial reduction in power dissipation compared to a full $\overline{RAS}/\overline{CAS}$ memory cycle.

\overline{CAS} Before \overline{RAS} Refresh*

\overline{CAS} before \overline{RAS} refresh is an on-chip refresh capability that eliminates the need for external refresh addresses. If \overline{CAS} is held low for the specified set-up time (t_{FCS}) before \overline{RAS} goes low, the on-chip refresh control clock generators and refresh address counter are enabled. An internal refresh operation automatically occurs and the refresh address counter is internally incremented in preparation for the next \overline{CAS} before \overline{RAS} refresh operation.

Hidden \overline{CAS} Before \overline{RAS} Refresh

A hidden refresh cycle may be performed while maintaining the latest valid data at the output by extending the \overline{CAS} active time and cycling \overline{RAS} . The refresh row address is provided by the on-chip refresh address counter. This eliminates the need for the external row address that is required by DRAMs that do not have \overline{CAS} before \overline{RAS} refresh capability.

*Note: \overline{CAS} Before \overline{RAS} refresh available on request.

FUJITSU

MB81416-10
 MB81416-12
 MB81416-15

Description,
 (Continued)

CAS Before RAS Refresh Counter Test Cycle

A special timing sequence using the CAS before RAS Refresh Counter Test Cycle provides a convenient way to verify the functionality of the CAS before RAS refresh circuitry. The cycle begins with a CAS before RAS operation. Then CAS is cycled "high" and then "low". This enables a read, write, or read-modify-write operation to occur. Four memory cells are accessed with the location defined as follows:

Row Address —

Bits A₀ through A₆ are supplied by the on-chip refresh counter. Bit A₇ is set low internally.

Column Address —

Bits A₁ through A₆ are strobed-in by the falling edge of CAS as in a normal memory cycle.

Suggested $\overline{\text{CAS}}$ Before RAS Refresh Counter Test Procedure

The $\overline{\text{CAS}}$ before RAS Refresh Counter Test Cycle timing is used in each of the following steps:

1. Initialize the internal refresh counter by performing 8 cycles.
2. Write a test pattern of "lows" into each set of 4 memory cells at a single column address and 128 row addresses. (The row addresses are supplied by the on-chip refresh counter.)
3. Using read-modify-write cycles, read the "lows" written during step 2 and write "highs" into the same memory locations. Perform this step 128 times so that "highs" are written into the 128 sets of 4 memory cells.
4. Read the highs written during step 3.
5. Compliment the test pattern and repeat steps 2, 3, and 4.

Page Mode

Page mode memory cycles provide faster access and lower power dissipation than normal memory cycles. In page mode, it is possible to read, write, or read-modify-write. As long as the applicable timing requirements are observed, it is possible to mix these cycles in any order. A page mode cycle begins with a normal cycle. While RAS is kept low to maintain the row address, $\overline{\text{CAS}}$ is cycled to strobe in additional column addresses. This eliminates the time required to setup and strobe sequential row addresses for the same page. Up to 64 nibble wide words may be accessed with the same row address.

Typical Characteristics Curves

CURRENT WAVEFORM ($V_{CC} = 5.5V, T_A = 25^\circ C$)

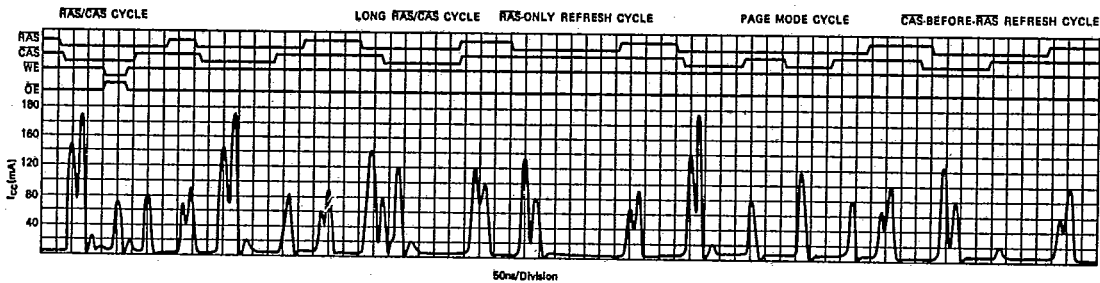

MB81416-10
 MB81416-12
 MB81416-15

**Typical Characteristics
 Curves**
 (Continued)

**NORMALIZED ACCESS TIME
 vs SUPPLY VOLTAGE**

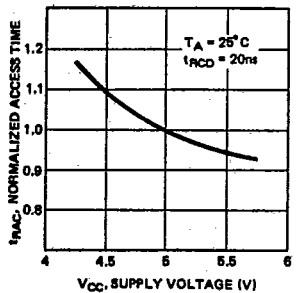

**NORMALIZED ACCESS TIME
 vs AMBIENT TEMPERATURE**

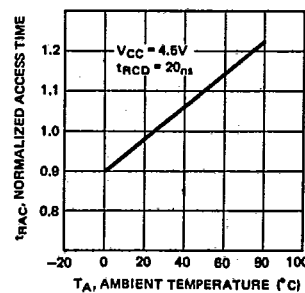

**OPERATING CURRENT vs
 CYCLE RATE**

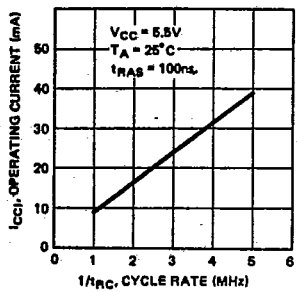

**OPERATING CURRENT vs
 SUPPLY VOLTAGE**

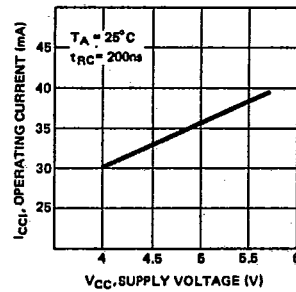

**OPERATING CURRENT vs
 AMBIENT TEMPERATURE**

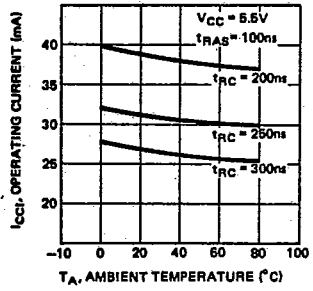

**STANDBY CURRENT vs
 SUPPLY VOLTAGE**

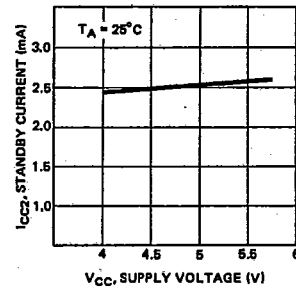

MB81416-10
 MB81416-12
 MB81416-15

**Typical Characteristics
 Curves**
 (Continued)

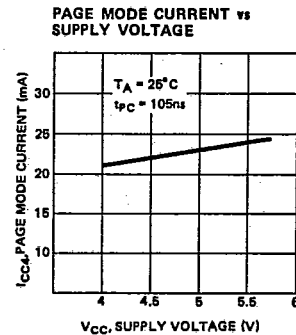
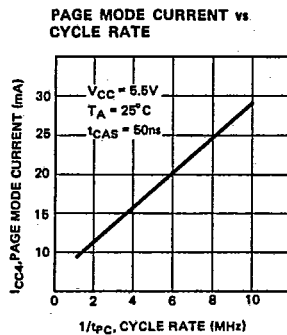
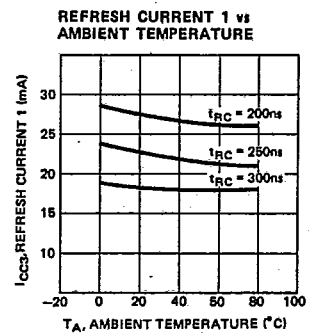
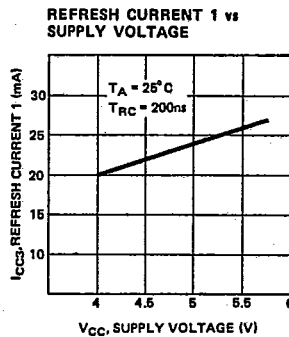
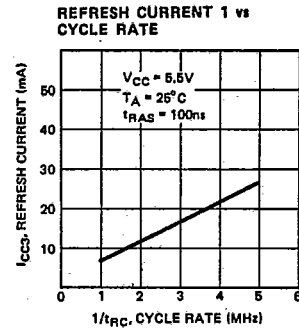
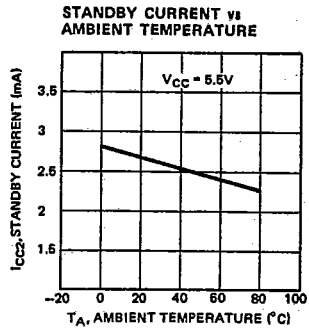

MBG1416-10
 MBG1416-12
 MBG1416-15

**Typical Characteristics
 Curves**
 (Continued)

**PAGE MODE CURRENT vs
 AMBIENT TEMPERATURE**

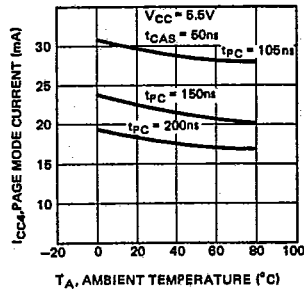

**REFRESH CURRENT 2 vs
 CYCLE RATE**

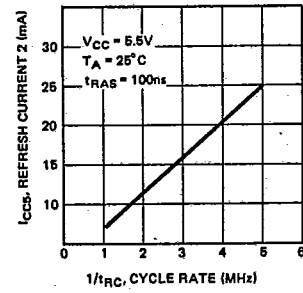

**REFRESH CURRENT 2 vs
 SUPPLY VOLTAGE**

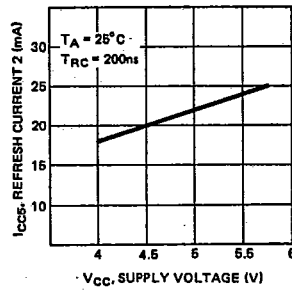

**REFRESH CURRENT 2 vs
 AMBIENT TEMPERATURE**

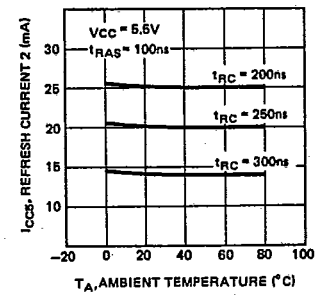

**ADDRESS AND DATA INPUT
 VOLTAGE vs SUPPLY VOLTAGE**

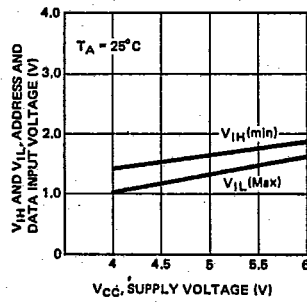

**ADDRESS AND DATA INPUT
 VOLTAGE vs AMBIENT
 TEMPERATURE**

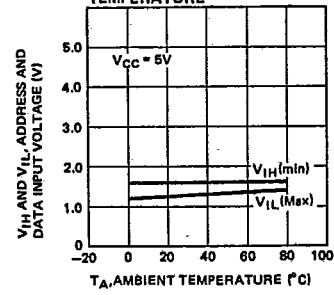

M881416-10
M881416-12
M881416-18

**Typical Characteristics
Curves**
(Continued)

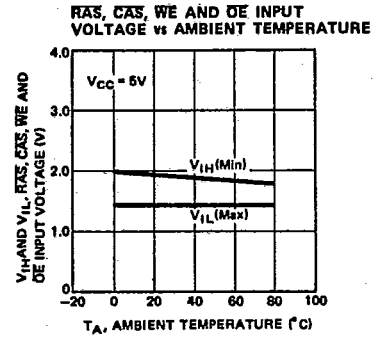
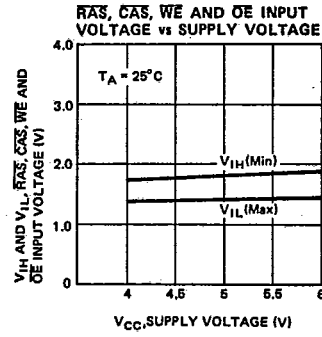

SUPPLY CURRENT vs SUPPLY VOLTAGE DURING POWER UP

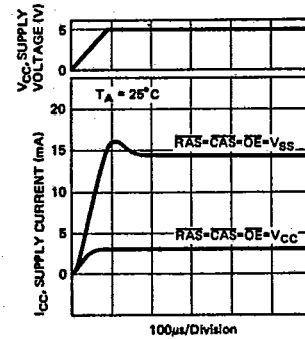
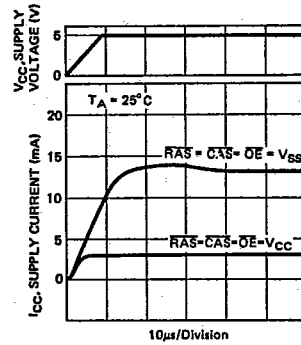

MB81416-10
 MB81416-12
 MB81416-15

**Typical Characteristics
 Curves**
 (Continued)

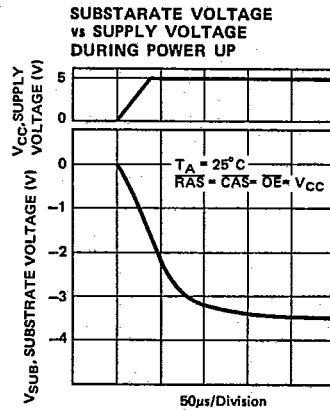

CURRENT WAVEFORM DURING POWER UP (ON MEMORY BOARD)

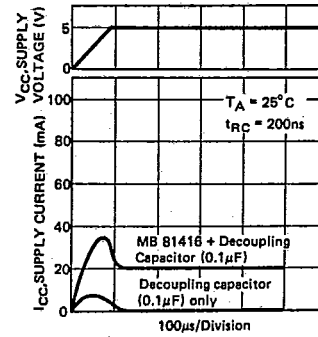
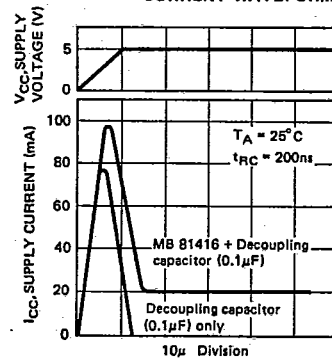

MB81416-10
 MB81416-12
 MB81416-15

Package Dimensions
 Dimensions in inches
 (millimeters)

**18-Lead Cerdip
 Dual In-Line Package
 DIP-18C-C01**

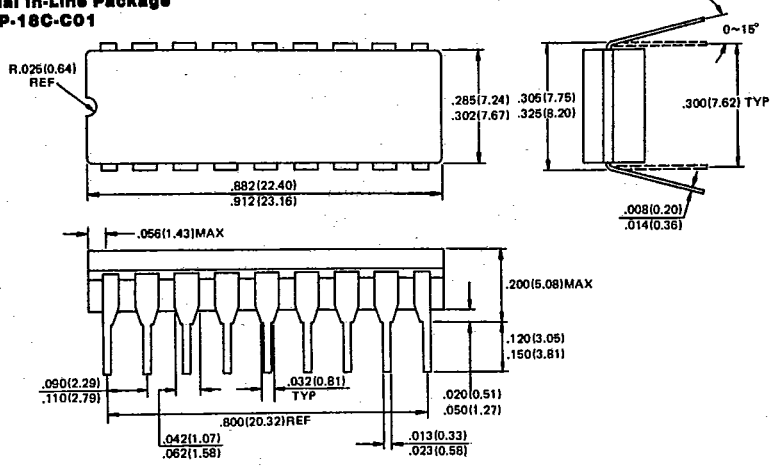

**18-Lead Plastic
 Dual In-Line Package
 DIP-18P-M01**

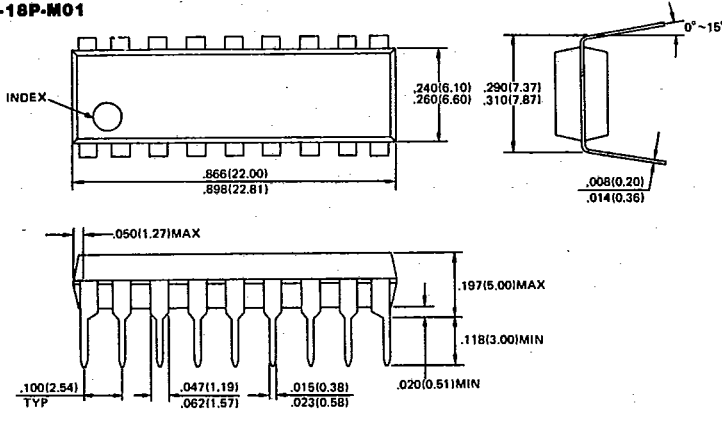

MB81416-10
 MB81416-12
 MB81416-15

Package Dimensions
 (Continued)
 Dimensions in inches
 (millimeters)

18-PAD CERAMIC (FRIT SEAL) LEADLESS CHIP CARRIER
 (CASE No.: LCC-18C-F02)

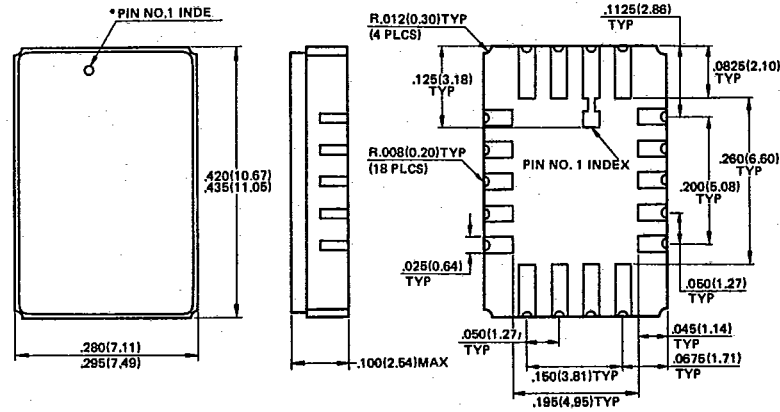

*Shape of Pin 1 Index: Subject to change without notice