



# CY7C251 CY7C254

## 16K x 8 Power Switched and Reprogrammable PROM

### Features

- CMOS for optimum speed/power
- Windowed for reprogrammability
- High speed
  - 45 ns
- Low power
  - 550 mW (commercial)
  - 660 mW (military)
- Super low standby power (7C251)
  - Less than 165 mW when deselected
  - Fast access: 50 ns
- EPROM technology 100% programmable
- Slim 300-mil or standard 600-mil packaging available
- $5V \pm 10\% V_{CC}$ , commercial and military
- TTL-compatible I/O
- Direct replacement for bipolar PROMs
- Capable of withstanding >2001V static discharge

### Functional Description

The CY7C251 and CY7C254 are high-performance 16,384-word by 8-bit CMOS PROMs. When deselected, the CY7C251 automatically powers down into a low-power stand-by mode. It is packaged in a 300-mil-wide package. The 7C254 is packaged in a 600-mil-wide package and does not power down when deselected. The 7C251 and 7C254 are available in reprogrammable packages equipped with an erasure window; when exposed to UV light, these PROMs are erased and can then be reprogrammed. The memory cells utilize proven EPROM floating gate technology and byte-wide intelligent programming algorithms.

The CY7C251 and CY7C254 are plug-in replacements for bipolar devices and offer the advantages of lower power, superior performance, and high programming yield. The EPROM cell requires only 12.5V for the super voltage, and low current requirements allow for gang programming. The EPROM cells allow each memory location to be tested 100% because each location is written into, erased, and repeatedly exercised prior to encapsulation. Each PROM is also tested for AC performance to guarantee that after customer programming, the product will meet DC and AC specification limits.

Reading is accomplished by placing all four chip selects in their active states. The contents of the memory location addressed by the address lines ( $A_0 - A_{13}$ ) will become available on the output lines ( $O_0 - O_7$ ).

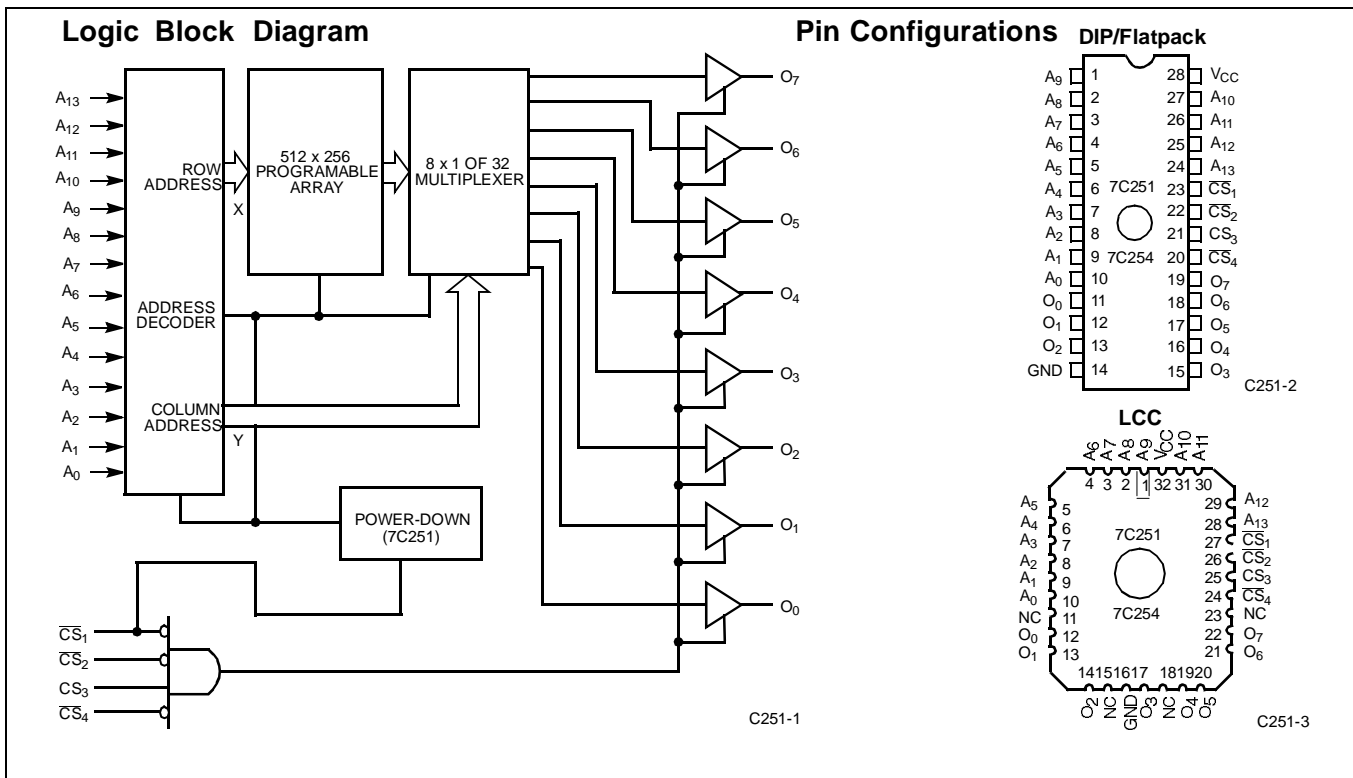



**Selection Guide**

		<b>7C251-45, 7C254-45</b>	<b>7C251-55, 7C254-55</b>	<b>7C251-65, 7C254-65</b>
Maximum Access Time (ns)		45	55	65
Maximum Operating Current (mA)	Commercial	100	100	100
	Military	120	120	120
Standby Current (mA) (7C251 only)	Commercial	30	30	30
	Military	35	35	35

**Maximum Ratings**

(Above which the useful life may be impaired. For user guidelines, not tested.)

Storage Temperature ..... -65°C to +150°C

Ambient Temperature with Power Applied..... -55°C to +125°C

Supply Voltage to Ground Potential (Pin 28 to Pin 14) ..... -0.5V to +7.0V

DC Voltage Applied to Outputs in High Z State ..... -0.5V to +7.0V

DC Input Voltage..... -3.0V to +7.0V

DC Program Voltage (Pin 22) ..... 13.5V

Static Discharge Voltage ..... >2001V (per MIL-STD-883, Method 3015)

Latch-Up Current ..... >200 mA

UV Exposure ..... 7258 Wsec/cm<sup>2</sup>

**Operating Range**

Range	Ambient Temperature	V <sub>CC</sub>
Commercial	0°C to +70°C	5V ±10%
Industrial <sup>[1]</sup>	-40°C to +85°C	5V ±10%
Military <sup>[2]</sup>	-55°C to +125°C	5V ±10%

**Electrical Characteristics** Over the Operating Range<sup>[3, 4]</sup>

Parameter	Description	Test Conditions	7C251-45,55,65 7C254-45,55,65		Unit
			Min.	Max.	
V <sub>OH</sub>	Output HIGH Voltage	V <sub>CC</sub> = Min., I <sub>OH</sub> = -4.0 mA	2.4		V
V <sub>OL</sub>	Output LOW Voltage	V <sub>CC</sub> = Min., I <sub>OL</sub> = 16.0 mA		0.5	V
V <sub>IH</sub>	Input HIGH Level	Guaranteed Input Logical HIGH Voltage for All Inputs	2.0		V
V <sub>IL</sub>	Input LOW Level	Guaranteed Input Logical LOW Voltage for All Inputs		0.8	V
I <sub>IX</sub>	Input Current	GND ≤ V <sub>IN</sub> ≤ V <sub>CC</sub>	-10	+10	μA
V <sub>CD</sub>	Input Diode Clamp Voltage		Note 4		
I <sub>OZ</sub>	Output Leakage Current	GND ≤ V <sub>OUT</sub> ≤ V <sub>CC</sub> , Output Disabled	-40	+40	μA
I <sub>OS</sub>	Output Short Circuit Current <sup>[5]</sup>	V <sub>CC</sub> = Max., V <sub>OUT</sub> = GND	-20	-90	mA
I <sub>CC</sub>	Power Supply Current	V <sub>CC</sub> = Max., I <sub>OUT</sub> = 0 mA	Com'l	100	mA
			Mil	120	
I <sub>SB</sub>	Standby Supply Current (7C251)	V <sub>CC</sub> = Max., CS <sub>1</sub> = V <sub>IH</sub> , I <sub>OUT</sub> = 0 mA	Com'l	30	mA
			Mil	35	
V <sub>PP</sub>	Programming Supply Voltage		12	13	V
I <sub>PP</sub>	Programming Supply Current			50	mA
V <sub>IHP</sub>	Input HIGH Programming Voltage		3.0		V
V <sub>ILP</sub>	Input LOW Programming Voltage			0.4	V

**Notes:**

1. Contact a Cypress representative regarding industrial temperature range specification.
2. T<sub>A</sub> is the "instant on" case temperature.
3. See the last page of this specification for Group A subgroup testing information.
4. See the "Introduction to CMOS PROMs" section of the Cypress Data Book for general information on testing.
5. For test purposes, not more than one output at a time should be shorted. Short circuit test duration should not exceed 30 seconds.

**Capacitance<sup>[4]</sup>**

Parameter	Description	Test Conditions	Max.	Unit
$C_{IN}$	Input Capacitance	$T_A = 25^\circ\text{C}$ , $f = 1\text{ MHz}$ , $V_{CC} = 5.0\text{V}$	10	pF
$C_{OUT}$	Output Capacitance		10	pF

**AC Test Loads and Waveforms<sup>[4]</sup>**

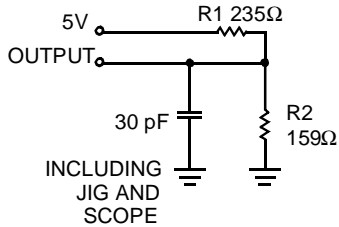

**(a) Normal Load**

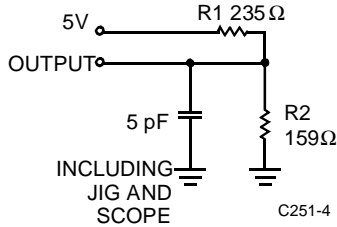

**(b) High Z Load**

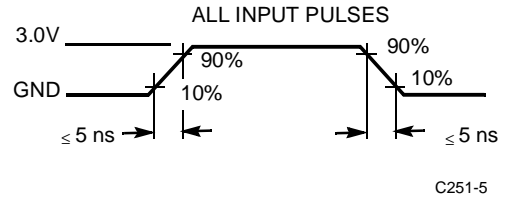

C251-5

Equivalent to: THÉVENINEQUIVALENT

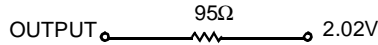

C251-6

**Switching Characteristics Over the Operating Range<sup>[2, 4]</sup>**

Parameter	Description	7C251-45 7C254-45		7C251-55 7C254-55		7C251-65 7C254-65		Unit
		Min.	Max.	Min.	Max.	Min.	Max.	
$t_{AA}$	Address to Output Valid		45		55		65	ns
$t_{HZCS1}$	Chip Select Inactive to High Z <sup>[6]</sup>		25		30		35	ns
$t_{HZCS2}$	Chip Select Inactive to High Z (7C251, $\overline{CS}_1$ Only)		50		60		70	ns
$t_{ACS1}$	Chip Select Active to Output Valid <sup>[6]</sup>		25		30		35	ns
$t_{ACS2}$	Chip Select Active to Output Valid (7C251, $\overline{CS}_1$ Only)		50		60		70	ns
$t_{PU}$	Chip Select Active to Power Up (7C251)	0		0		0		ns
$t_{PD}$	Chip Select Inactive to Power Down (7C251) <sup>[7]</sup>		50		60		70	ns

**Switching Waveform<sup>[4, 7]</sup>**

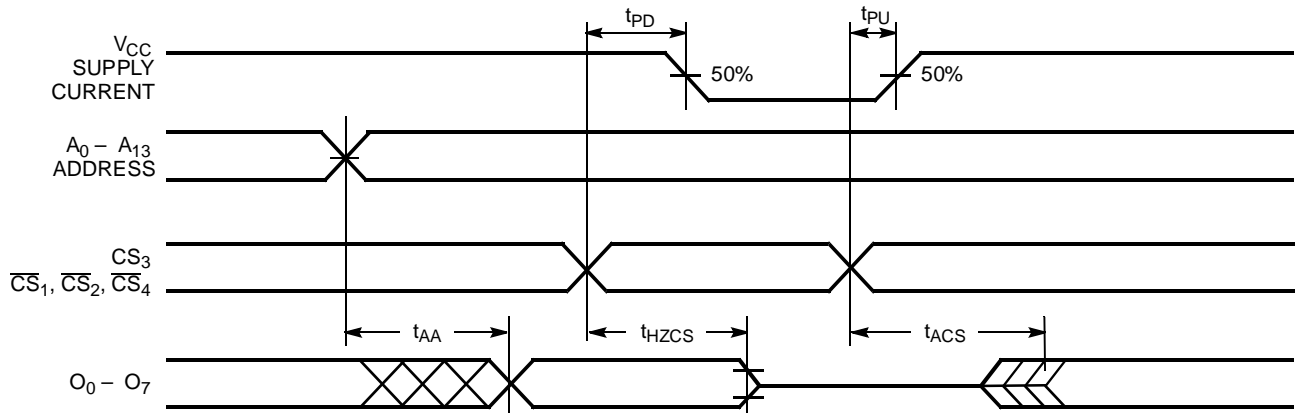

C251-7

**Notes:**

- $t_{HZCS1}$  and  $t_{ACS1}$  refers to 7C254 (all chip selects); and 7C251 ( $\overline{CS}_2$ ,  $CS_3$  and  $\overline{CS}_4$  only).
- Power-down controlled by 7C251  $CS_1$  only.

### Erase Characteristics

Wavelengths of light less than 4000 angstroms begin to erase the 7C251 and 7C254 in the windowed package. For this reason, an opaque label should be placed over the window if the PROM is exposed to sunlight or fluorescent lighting for extended periods of time.

The recommended dose of ultraviolet light for erasure is a wavelength of 2537 angstroms for a minimum dose (UV intensity x exposure time) of 25 Wsec/cm<sup>2</sup>. For an ultraviolet lamp with a 12 mW/cm<sup>2</sup> power rating, the exposure time would be approximately 35 minutes. The 7C251 or 7C254 needs to be within 1 inch of the lamp during erasure. Permanent damage may result if the PROM is exposed to high-intensity UV light for an extended period of time. 7258 Wsec/cm<sup>2</sup> is the recommended maximum dosage.

### Blankcheck

Blankcheck is accomplished by performing a verify cycle ( $\overline{VFY}$  toggles on each address), sequencing through all memory address locations, where all the data read will be zeros.

### Programming Information

Programming support is available from Cypress as well as from a number of third-party software vendors. For detailed programming information, including a listing of software packages, please see the PROM Programming Information located at the end of this section. Programming algorithms can be obtained from any Cypress representative.

**Table 1. Mode Selection**

Mode	Pin Function <sup>[8]</sup>						
	Read or Output Disable	A <sub>13</sub> - A <sub>0</sub>	$\overline{CS}_4$	CS <sub>3</sub>	$\overline{CS}_2$	$\overline{CS}_1$	O <sub>7</sub> - O <sub>0</sub>
	Other	A <sub>13</sub> - A <sub>0</sub>	NA	$\overline{VFY}$	V <sub>PP</sub>	PGM	D <sub>7</sub> - D <sub>0</sub>
Read		A <sub>13</sub> - A <sub>0</sub>	V <sub>IL</sub>	V <sub>IH</sub>	V <sub>IL</sub>	V <sub>IL</sub>	O <sub>7</sub> - O <sub>0</sub>
Output Disable		A <sub>13</sub> - A <sub>0</sub>	X	X	X	V <sub>IH</sub>	High Z
Output Disable		A <sub>13</sub> - A <sub>0</sub>	X	X	V <sub>IH</sub>	X	High Z
Output Disable		A <sub>13</sub> - A <sub>0</sub>	X	V <sub>IL</sub>	X	X	High Z
Output Disable		A <sub>13</sub> - A <sub>0</sub>	V <sub>IH</sub>	X	X	X	High Z
Program		A <sub>13</sub> - A <sub>0</sub>	X	V <sub>IHP</sub>	V <sub>PP</sub>	V <sub>ILP</sub>	D <sub>7</sub> - D <sub>0</sub>
Program Verify		A <sub>13</sub> - A <sub>0</sub>	X	V <sub>ILP</sub>	V <sub>PP</sub>	V <sub>IHP</sub>	O <sub>7</sub> - O <sub>0</sub>
Program Inhibit		A <sub>13</sub> - A <sub>0</sub>	X	V <sub>IHP</sub>	V <sub>PP</sub>	V <sub>IHP</sub>	High Z
Blank Check		A <sub>13</sub> - A <sub>0</sub>	X	V <sub>ILP</sub>	V <sub>PP</sub>	V <sub>IHP</sub>	O <sub>7</sub> - O <sub>0</sub>

**Note:**

8. X = "don't care" but not to exceed V<sub>CC</sub> ±5%.

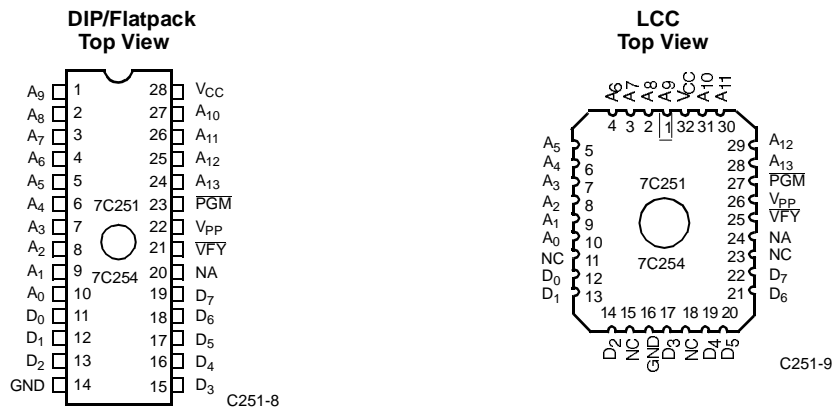

**Figure 1. Programmable Pinout**

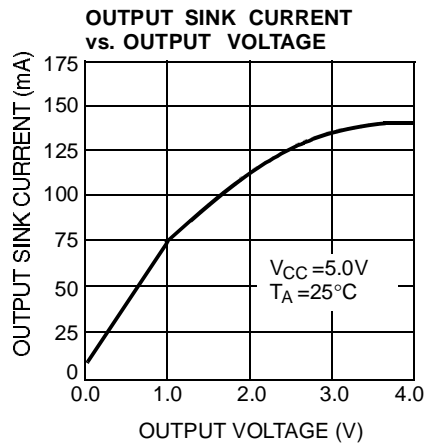
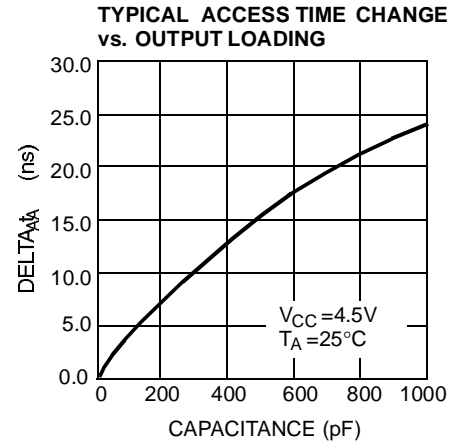
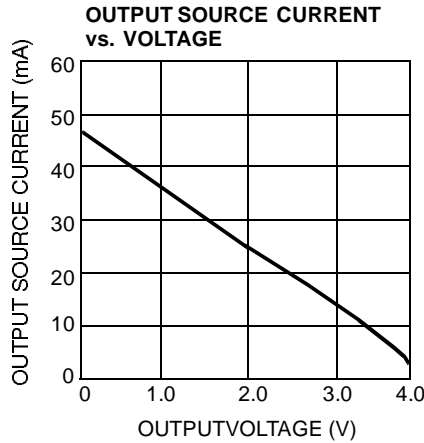
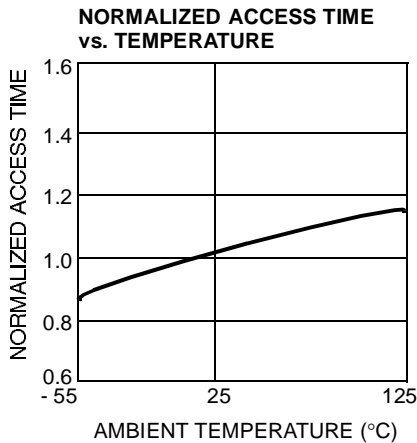
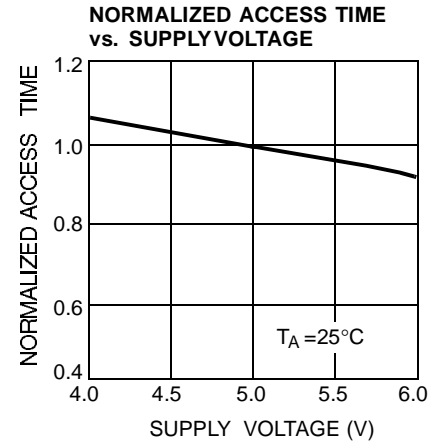
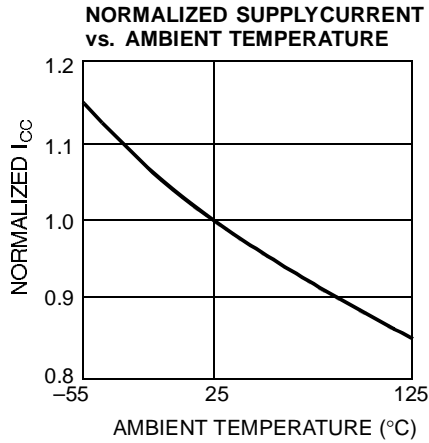
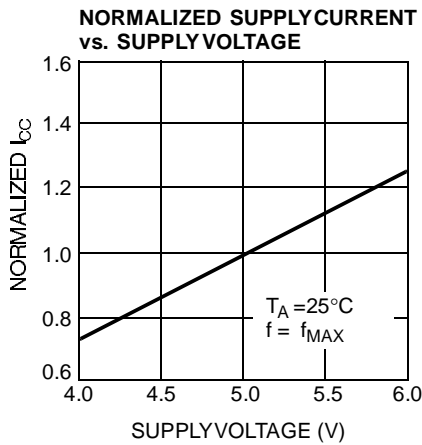
**Typical DC and AC Characteristics**

**Ordering Information<sup>[9]</sup>**

Speed (ns)	Ordering Code	Package Name	Package Type	Operating Range
45	CY7C251-45PC	P21	28-Lead (300-Mil) Molded DIP	Commercial
	CY7C251-45WC	W22	28-Lead (300-Mil) Windowed CerDIP	
	CY7C251-45DMB	D22	28-Lead (300-Mil) CerDIP	Military
	CY7C251-45WMB	W22	28-Lead (300-Mil) Windowed CerDIP	
55	CY7C251-55PC	P21	28-Lead (300-Mil) Molded DIP	Commercial
	CY7C251-55WC	W22	28-Lead (300-Mil) Windowed CerDIP	
	CY7C251-55DMB	D22	28-Lead (300-Mil) CerDIP	Military
	CY7C251-55LMB	L55	32-Pin Rectangular Leadless Chip Carrier	
	CY7C251-55QMB	Q55	32-Pin Windowed Rectangular Leadless Chip Carrier	
	CY7C251-55WMB	W22	28-Lead (300-Mil) Windowed CerDIP	
65	CY7C251-65PC	P21	28-Lead (300-Mil) Molded DIP	Commercial
	CY7C251-65WC	W22	28-Lead (300-Mil) Windowed CerDIP	
	CY7C251-65DMB	D22	28-Lead (300-Mil) CerDIP	Military
	CY7C251-65LMB	L55	32-Pin Rectangular Leadless Chip Carrier	
	CY7C251-65QMB	Q55	32-Pin Windowed Rectangular Leadless Chip Carrier	
	CY7C251-65WMB	W22	28-Lead (300-Mil) Windowed CerDIP	

Speed (ns)	Ordering Code	Package Name	Package Type	Operating Range
45	CY7C254-45PC	P15	28-Lead (600-Mil) Molded DIP	Commercial
	CY7C254-45WC	W16	28-Lead (600-Mil) Windowed CerDIP	
	CY7C254-45DMB	D16	28-Lead (600-Mil) CerDIP	Military
	CY7C254-45WMB	W16	28-Lead (600-Mil) Windowed CerDIP	
55	CY7C254-55PC	P15	28-Lead (600-Mil) Molded DIP	Commercial
	CY7C254-55WC	W16	28-Lead (600-Mil) Windowed CerDIP	
	CY7C254-55DMB	D16	28-Lead (600-Mil) CerDIP	Military
	CY7C254-55QMB	Q55	32-Pin Windowed Rectangular Leadless Chip Carrier	
	CY7C254-55WMB	W16	28-Lead (600-Mil) Windowed CerDIP	
65	CY7C254-65PC	P15	28-Lead (600-Mil) Molded DIP	Commercial
	CY7C254-65WC	W16	28-Lead (600-Mil) Windowed CerDIP	
	CY7C254-65DMB	D16	28-Lead (600-Mil) CerDIP	Military
	CY7C254-65QMB	Q55	32-Pin Windowed Rectangular Leadless Chip Carrier	
	CY7C254-65WMB	W16	28-Lead (600-Mil) Windowed CerDIP	

**Note:**

9. Most of these products are available in industrial temperature range. Contact a Cypress representative for specifications and product availability.

**MILITARY SPECIFICATIONS**  
**Group A Subgroup Testing**
**DC Characteristics**

Parameter	Subgroups
$V_{OH}$	1, 2, 3
$V_{OL}$	1, 2, 3
$V_{IH}$	1, 2, 3
$V_{IL}$	1, 2, 3
$I_{IX}$	1, 2, 3
$I_{OZ}$	1, 2, 3
$I_{CC}$	1, 2, 3
$I_{SB}^{[10]}$	1, 2, 3

**Switching Characteristics**

Parameter	Subgroups
$t_{AA}$	7, 8, 9, 10, 11
$t_{ACS1}^{[11]}$	7, 8, 9, 10, 11
$t_{ACS2}^{[10]}$	7, 8, 9, 10, 11

**SMD Cross Reference**

SMD Number	Suffix	Cypress Number
5962-8953701	YX	CY7C251-65WMB
5962-8953701	ZX	CY7C251-65TMB
5962-8953701	VX	CY7C251-65QMB
5962-8953702	YX	CY7C251-55WMB
5962-8953702	ZX	CY7C251-55TMB
5962-8953702	VX	CY7C251-55QMB
5962-8953801	XX	CY7C254-65WMB
5962-8953801	ZX	CY7C254-65TMB
5962-8953801	VX	CY7C254-65QMB
5962-8953802	XX	CY7C254-55WMB
5962-8953802	ZX	CY7C254-55TMB
5962-8953802	VX	CY7C254-55QMB

**Notes:**

 10. 7C251 ( $\overline{CS}_1$  only).

 11. 7C254 and 7C251 ( $\overline{CS}_2$ ,  $CS_3$  and  $\overline{CS}_4$  only).

Document #: 38-00056-G

**Package Diagrams**

**28-Lead (600-Mil) CerDIP D16**  
MIL-STD-1835 D-10 Config.A

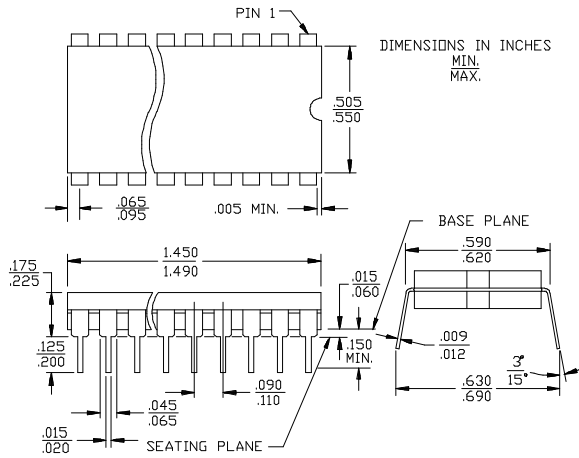

**28-Lead (300-Mil) CerDIP D22**  
MIL-STD-1835 D-15 Config. A

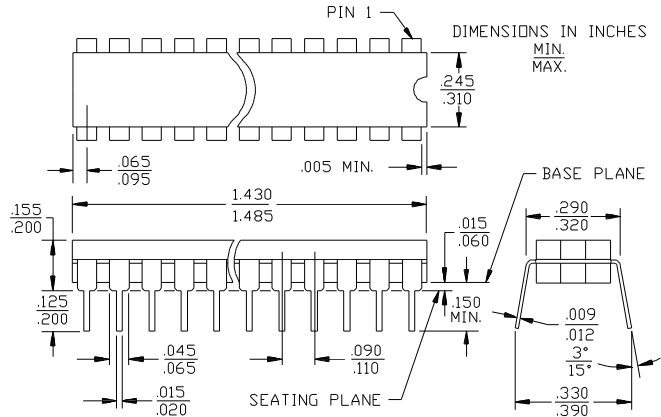

**32-Pin Rectangular Leadless Chip Carrier L55**  
MIL-STD-1835 C-12

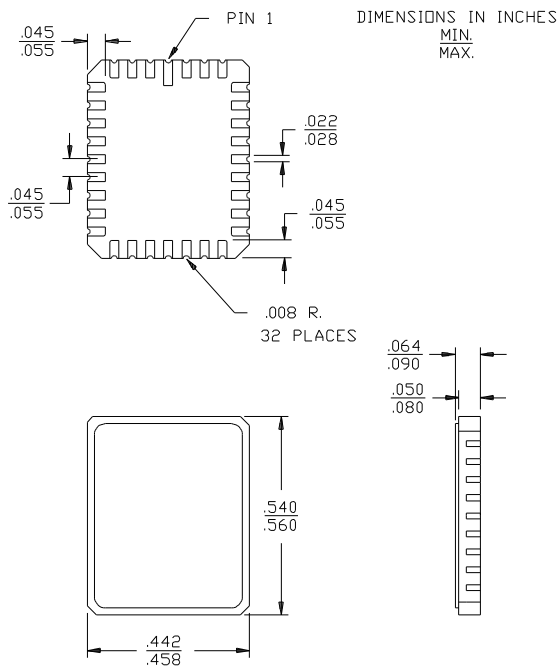

**32-Pin Windowed Rectangular Leadless Chip Carrier Q55**  
MIL-STD-1835 C-12

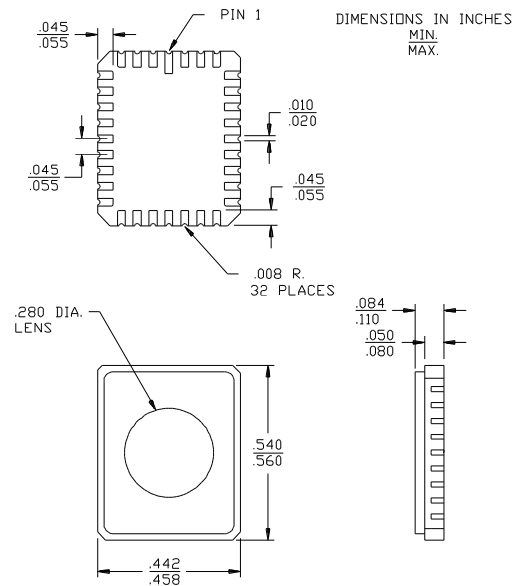



Package Diagrams (continued)

**28-Lead (600-Mil) Molded DIP P15**

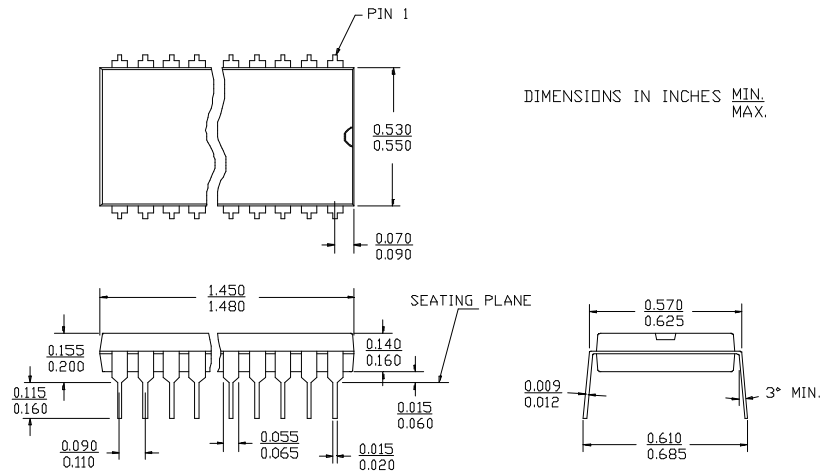

**28-Lead (300-Mil) Molded DIP P21**

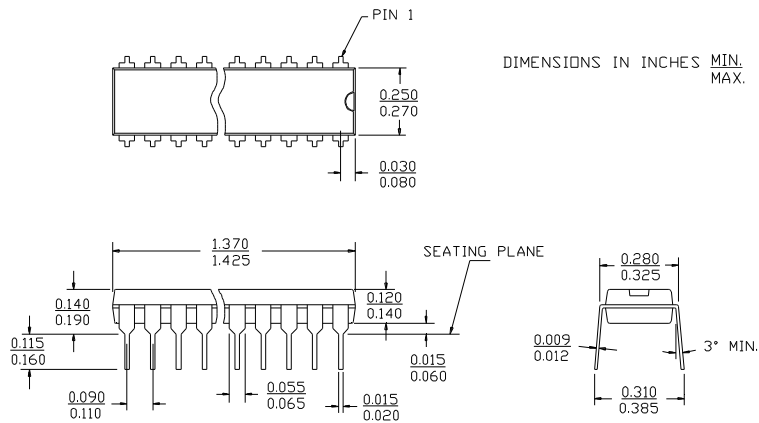

Package Diagrams (continued)

**28-Lead (600-Mil) Windowed CerDIP W16**  
MIL-STD-1835 D-10 Config. A

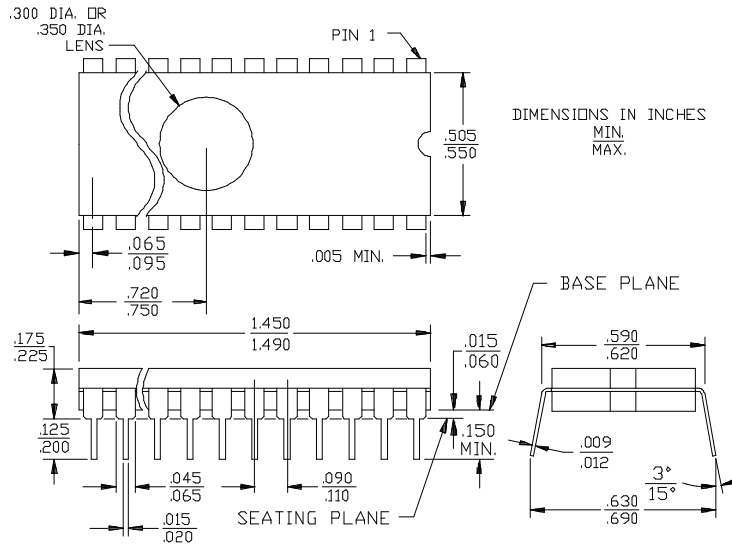

**28-Lead (300-Mil) Windowed CerDIP W22**  
MIL-STD-1835 D-15 Config. A

