

128K (16K x 8-Bit) CMOS EPROM
Features

- **Wide speed range**
 - 45 ns to 200 ns (commercial and military)
- **Low power**
 - 248 mW (commercial)
 - 303 mW (military)
- **Low standby power**
 - Less than 83 mW when deselected
- **±10% Power supply tolerance**

Functional Description

The CY27C128 is a high-performance 16,384-word by 8-bit CMOS EPROM. When disabled (\overline{CE} HIGH), the

CY27C128 automatically powers down into a low-power stand-by mode. The CY27C128 is packaged in the industry standard 600-mil DIP and LCC packages. The CY27C128 is also available in a Cer-DIP package equipped with an erasure window to provide for reprogrammability. When exposed to UV light, the EPROM is erased and can be reprogrammed. The memory cells utilize proven EPROM floating gate technology and byte-wide intelligent programming algorithms.

The CY27C128 offers the advantage of lower power and superior performance and programming yield. The EPROM cell requires only 12.5V for the super voltage,

and low current requirements allow for gang programming. The EPROM cells allow each memory location to be tested 100% because each location is written into, erased, and repeatedly exercised prior to encapsulation. Each EPROM is also tested for AC performance to guarantee that after customer programming, the product will meet both DC and AC specification limits.

Reading the CY27C128 is accomplished by placing active LOW signals on \overline{OE} and \overline{CE} . The contents of the memory location addressed by the address lines ($A_0 - A_{13}$) will become available on the output lines ($O_0 - O_7$).

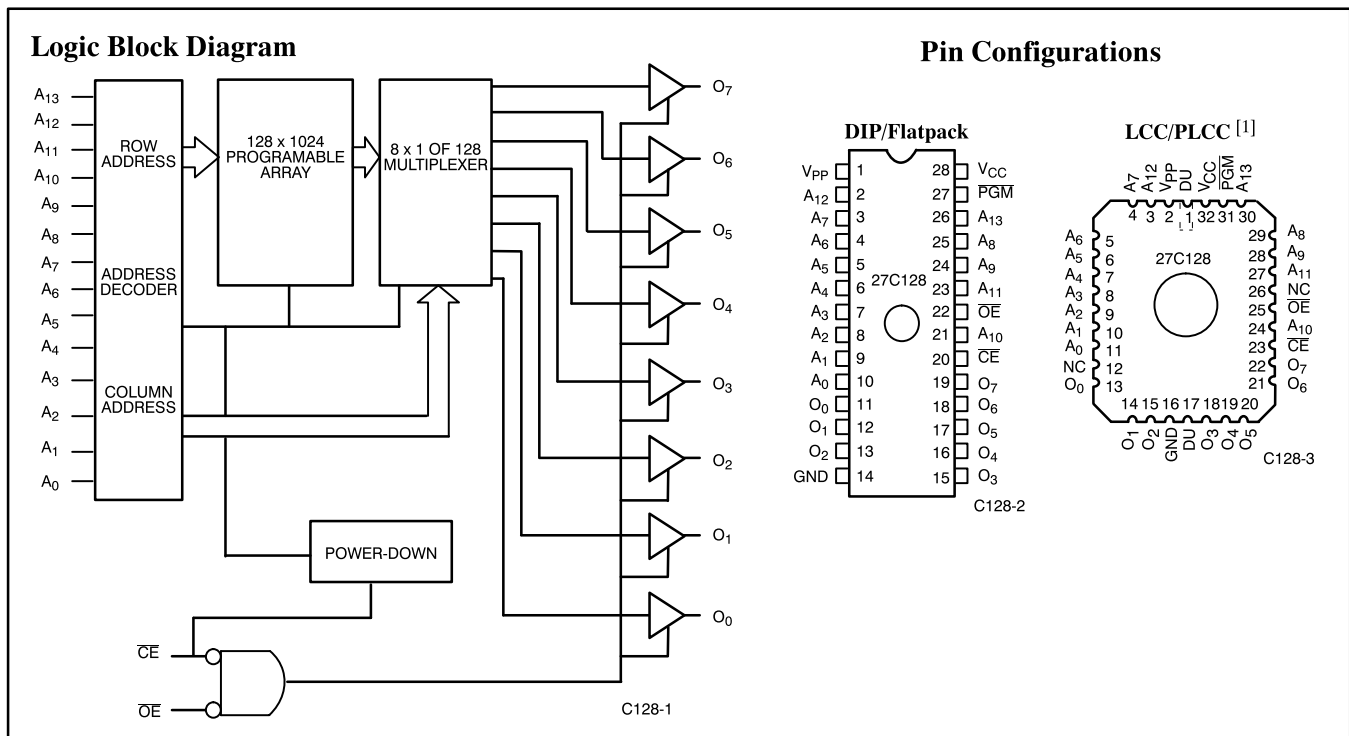
Selection Guide

		27C128-45	27C128-55	27C128-70	27C128-90	27C128-120	27C128-150	27C128-200
Maximum Access Time (ns)		45	55	70	90	120	150	200
Maximum Operating Current (mA) ^[2]	Com'l	45	45	45	45	45	45	45
	Mil	55	55	55	55	55	55	55
Standby Current (mA)	Com'l	15	15	15	15	15	15	15
	Mil	20	20	20	20	20	20	20
Chip Select Time (ns)		45	55	70	90	120	150	200
Output Enable Time (ns)		15	20	25	30	30	40	40

Notes:

1. For PLCC only: Pins 1 and 17 are common and tied to the die attach pad. They must therefore be DU (don't use) for the PLCC package.
2. Add 2 mA/MHz for AC power component.

Maximum Ratings

(Above which the useful life may be impaired. For user guidelines, not tested.)

Storage Temperature -65°C to +150°C
 Ambient Temperature with
 Power Applied -55°C to +125°C
 Supply Voltage to Ground Potential -0.5V to +7.0V
 DC Voltage Applied to Outputs
 in High Z State -0.5V to +7.0V
 DC Input Voltage -3.0V to +7.0V
 DC Program Voltage 13.0V
 Static Discharge Voltage >2001V
 (per MIL-STD-883, Method 3015)

Latch-Up Current >200 mA
 UV Exposure 7258 Wsec/cm²

Operating Range

Range	Ambient Temperature	V _{CC}
Commercial	0°C to +70°C	5V ±10%
Industrial ^[3]	-40°C to +85°C	5V ±10%
Military ^[4]	-55°C to +125°C	5V ±10%

Electrical Characteristics Over the Operating Range^[5]

Parameter	Description	Test Conditions	27C128-45, 55, 70, 90, 120, 150, 200		Unit	
			Min.	Max.		
V _{OH}	Output HIGH Voltage	V _{CC} = Min., I _{OH} = -4.0 mA	2.4		V	
V _{OL}	Output LOW Voltage	V _{CC} = Min., I _{OL} = 16.0 mA ^[6]		0.4	V	
V _{IH}	Input HIGH Level	Guaranteed Input Logical HIGH Voltage for All Inputs	2.0	V _{CC}	V	
V _{IL}	Input LOW Level	Guaranteed Input Logical LOW Voltage for All Inputs	-0.3	0.8	V	
I _{IX}	Input Current	GND ≤ V _{IN} ≤ V _{CC}	-10	+10	μA	
I _{OZ}	Output Leakage Current	GND ≤ V _{OUT} ≤ V _{CC} , Output Disabled	Commercial	-10	+10	μA
			Military	-40	+40	
I _{OS}	Output Short Circuit Current ^[7]	V _{CC} = Max., V _{OUT} = GND	-20	-90	mA	
I _{CC}	Power Supply Current ^[2]	V _{CC} = Max., V _{IN} = V _{IH} , I _{OUT} = 0 mA, \overline{CE} = V _{IL} , OE = V _{IH}	Commercial		45	mA
			Military		55	
I _{SB}	Standby Supply Current	V _{CC} = Max., \overline{CE} = V _{IH}	Commercial		15	mA
			Military		20	
V _{PP}	Programming Supply Voltage		12	13	V	
I _{PP}	Programming Supply Current			50	mA	
V _{IHP}	Input HIGH Programming Voltage		3.0		V	
V _{ILP}	Input LOW Programming Voltage			0.4	V	

Capacitance^[8]

Parameter	Description	Test Conditions	Max.	Unit
C _{IN}	Input Capacitance	T _A = 25°C, f = 1 MHz, V _{CC} = 5.0V	10	pF
C _{OUT}	Output Capacitance		10	pF

Notes:

- Contact a Cypress representative for information on industrial temperature range specifications.
- T_A is the "instant on" case temperature.
- See the last page of this specification for Group A subgroup testing information.
- I_{OL} = 12.0 mA for military devices.
- For test purposes, not more than one output at a time should be shorted. Short circuit test duration should not exceed 30 seconds.
- See Introduction to CMOS PROMs in this Data Book for general information on testing.

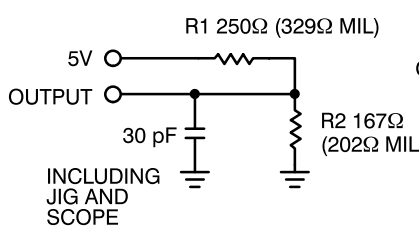
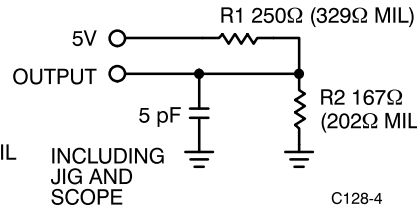
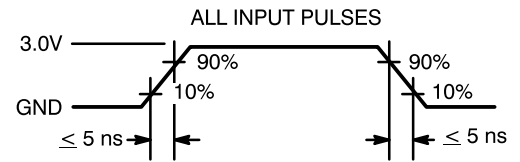
AC Test Loads and Waveforms

(a) Normal Load

(b) High Z Load

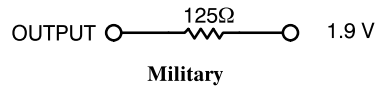
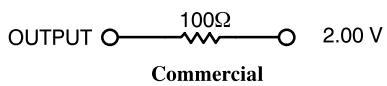
C128-5

Equivalent to: THÉVENIN EQUIVALENT

Switching Characteristics Over the Operating Range^[4, 7]

Parameter	Description	27C128-45		27C128-55		27C128-70		27C128-90		Unit
		Min.	Max.	Min.	Max.	Min.	Max.	Min.	Max.	
t _{AA}	Address to Output Valid		45		55		70		90	ns
t _{HZOE}	Output Enable Inactive to High Z		15		20		25		25	ns
t _{OE}	Output Enable Active to Output Valid		15		20		25		30	ns
t _{HZCE}	Chip Enable Inactive to High Z		20		25		25		25	ns
t _{ACE}	Chip Enable Active to Output Valid		45		55		70		90	ns
t _{PU}	Chip Enable Active to Power Up	0		0		0		0		ns
t _{PD}	Chip Enable Inactive to Power Down		45		55		70		90	ns
t _{OH}	Output Hold from Address Change	0		0		0		0		ns

Switching Characteristics Over the Operating Range^[4, 7] (continued)

Parameter	Description	27C128-120		27C128-150		27C128-200		Unit
		Min.	Max.	Min.	Max.	Min.	Max.	
t _{AA}	Address to Output Valid		120		150		200	ns
t _{HZOE}	Output Enable Inactive to High Z		30		30		30	ns
t _{OE}	Output Enable Active to Output Valid		30		40		40	ns
t _{HZCE}	Chip Enable Inactive to High Z		30		30		30	ns
t _{ACE}	Chip Enable Active to Output Valid		120		150		200	ns
t _{PU}	Chip Enable Active to Power Up	0		0		0		ns
t _{PD}	Chip Enable Inactive to Power Down		120		150		200	ns
t _{OH}	Output Hold from Address Change	0		0		0		ns

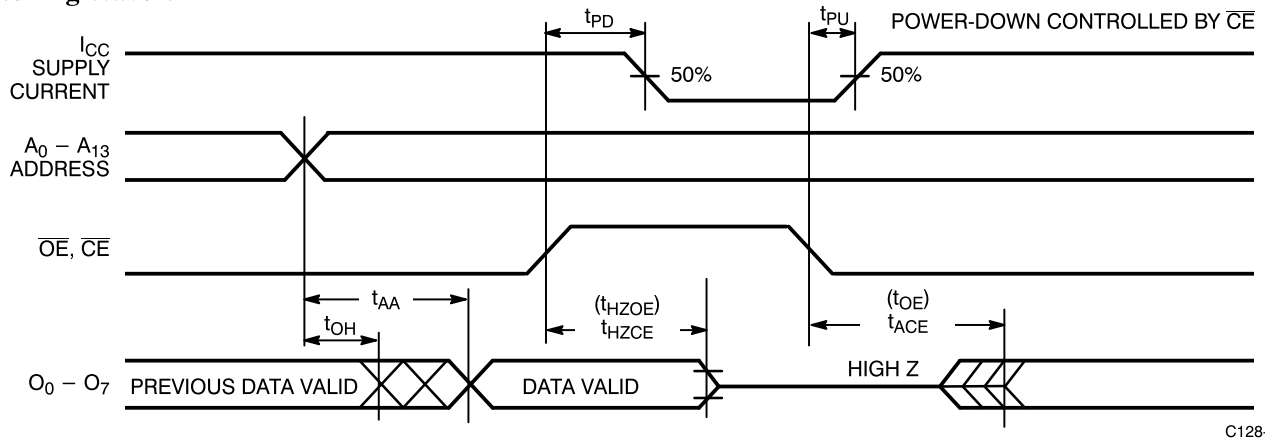
Switching Waveform

C128-6

Erase Characteristics

Wavelengths of light less than 4000 \AA begin to erase the 27C128 in the windowed package. For this reason, an opaque label should be placed over the window if the EPROM is exposed to sunlight or fluorescent lighting for extended periods of time.

The recommended dose of ultraviolet light for erasure is a wavelength of 2537 \AA for a minimum dose (UV intensity multiplied by exposure time) of 25 Wsec/cm^2 . For an ultraviolet lamp with a 12 mW/cm^2 power rating, the exposure time would be approximately 35 minutes. The CY27C128 needs to be within 1 inch of the lamp

during erasure. Permanent damage may result if the EPROM is exposed to high-intensity UV light for an extended period of time. 7258 Wsec/cm^2 is the recommended maximum dosage.

Programming Modes

Programming support is available from Cypress as well as from a number of third-party software vendors. For detailed programming information, including a listing of software packages, please see the EPROM Programming Information located at the end of this section. Programming algorithms can be obtained from any Cypress representative.

Table 1. CY27C128 Mode Selection

Mode	Pin Function ^[9]					
	A ₁₃ - A ₀	$\overline{\text{OE}}$	$\overline{\text{CE}}$	V _{PP}	$\overline{\text{PGM}}$	O ₇ - O ₀
Read	A ₁₃ - A ₀	V _{IL}	V _{IL}	X	Note 10	O ₇ - O ₀
Output Disable	A ₁₃ - A ₀	V _{IH}	X	X	Note 10	High Z
Power Down	A ₁₃ - A ₀	X	V _{IH}	X	Note 10	High Z

Notes:

9. X must be either V_{IL} or V_{IH}.

10. X must be either V_{IL} or V_{IH} (must not switch).

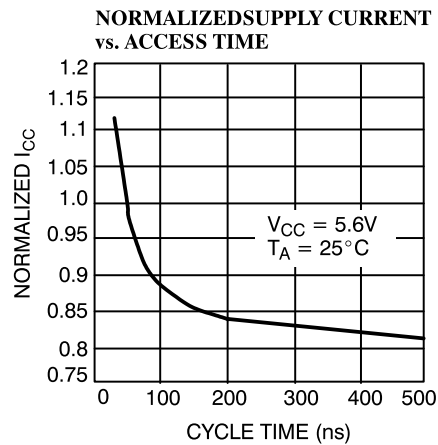
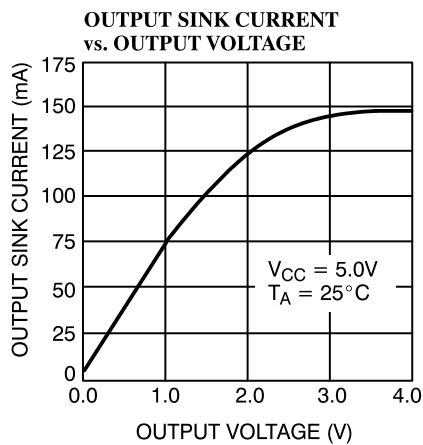
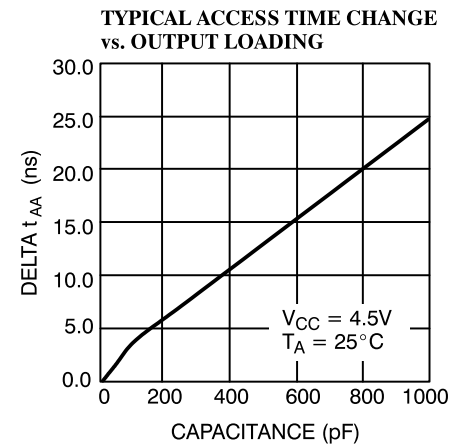
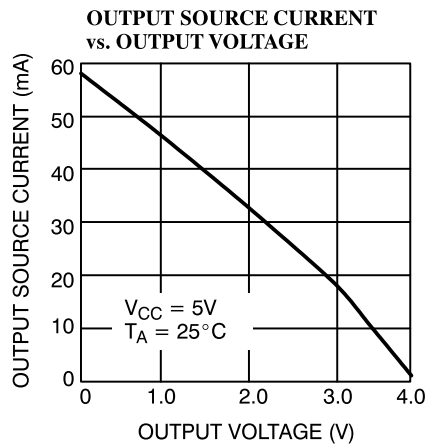
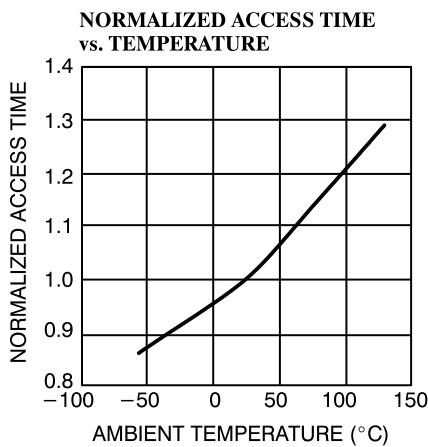
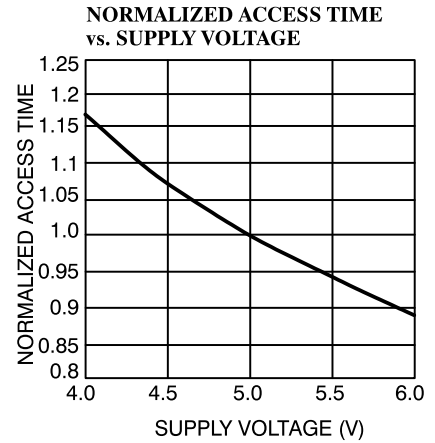
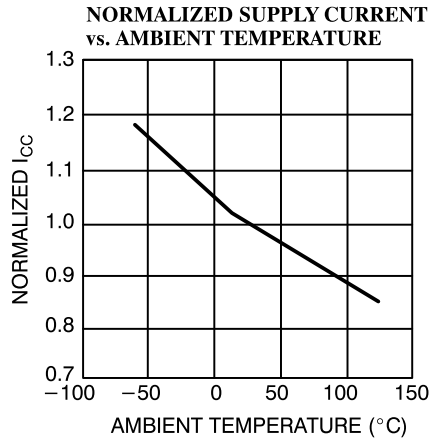
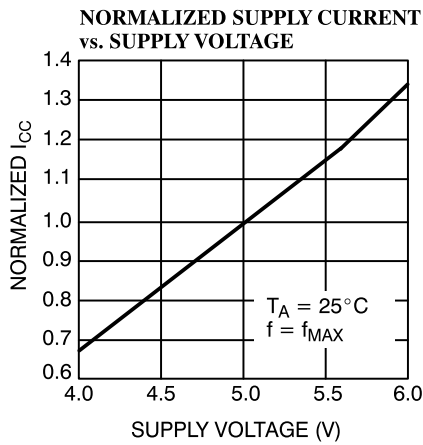
Typical DC and AC Characteristics

Ordering Information^[11]

Speed (ns)	Ordering Code	Package Name	Package Type	Operating Range
45	CY27C128-45JC	J65	32-Pin Rectangular Plastic Leaded Chip Carrier	Commercial
	CY27C128-45PC	P15	28-Lead (600-Mil) Molded DIP	
	CY27C128-45WC	W16	28-Lead (600-Mil) Windowed CerDIP	
	CY27C128-45WMB	W16	28-Lead (600-Mil) Windowed CerDIP	Military
55	CY27C128-55JC	J65	32-Pin Rectangular Plastic Leaded Chip Carrier	Commercial
	CY27C128-55PC	P15	28-Lead (600-Mil) Molded DIP	
	CY27C128-55WC	W16	28-Lead (600-Mil) Windowed CerDIP	
	CY27C128-55WMB	W16	28-Lead (600-Mil) Windowed CerDIP	Military
70	CY27C128-70JC	J65	32-Pin Rectangular Plastic Leaded Chip Carrier	Commercial
	CY27C128-70PC	P15	28-Lead (600-Mil) Molded DIP	
	CY27C128-70WC	W16	28-Lead (600-Mil) Windowed CerDIP	
	CY27C128-70WMB	W16	28-Lead (600-Mil) Windowed CerDIP	Military
90	CY27C128-90JC	J65	32-Pin Rectangular Plastic Leaded Chip Carrier	Commercial
	CY27C128-90PC	P15	28-Lead (600-Mil) Molded DIP	
	CY27C128-90WC	W16	28-Lead (600-Mil) Windowed CerDIP	
	CY27C128-90WMB	W16	28-Lead (600-Mil) Windowed CerDIP	Military
120	CY27C128-120JC	J65	32-Pin Rectangular Plastic Leaded Chip Carrier	Commercial
	CY27C128-120PC	P15	28-Lead (600-Mil) Molded DIP	
	CY27C128-120WC	W16	28-Lead (600-Mil) Windowed CerDIP	
	CY27C128-120WMB	W16	28-Lead (600-Mil) Windowed CerDIP	Military
150	CY27C128-150JC	J65	32-Pin Rectangular Plastic Leaded Chip Carrier	Commercial
	CY27C128-150PC	P15	28-Lead (600-Mil) Molded DIP	
	CY27C128-150WC	W16	28-Lead (600-Mil) Windowed CerDIP	
	CY27C128-150WMB	W16	28-Lead (600-Mil) Windowed CerDIP	Military
200	CY27C128-200JC	J65	32-Pin Rectangular Plastic Leaded Chip Carrier	Commercial
	CY27C128-200PC	P15	28-Lead (600-Mil) Molded DIP	
	CY27C128-200WC	W16	28-Lead (600-Mil) Windowed CerDIP	
	CY27C128-200WMB	W16	28-Lead (600-Mil) Windowed CerDIP	Military

Note:

11. Most of these products are available in industrial temperature range. Contact a Cypress representative for specifications and product availability.

MILITARY SPECIFICATIONS
Group A Subgroup Testing**DC Characteristics**

Parameter	Subgroups
V_{OH}	1, 2, 3
V_{OL}	1, 2, 3
V_{IH}	1, 2, 3
V_{IL}	1, 2, 3
I_{IX}	1, 2, 3
I_{OZ}	1, 2, 3
I_{CC}	1, 2, 3
I_{SB}	1, 2, 3

Switching Characteristics

Parameter	Subgroups
t_{AA}	7, 8, 9, 10, 11
t_{OE}	7, 8, 9, 10, 11
t_{ACE}	7, 8, 9, 10, 11

Document #: 38-00357

Package Diagrams

32-Lead Plastic Leaded Chip Carrier J65

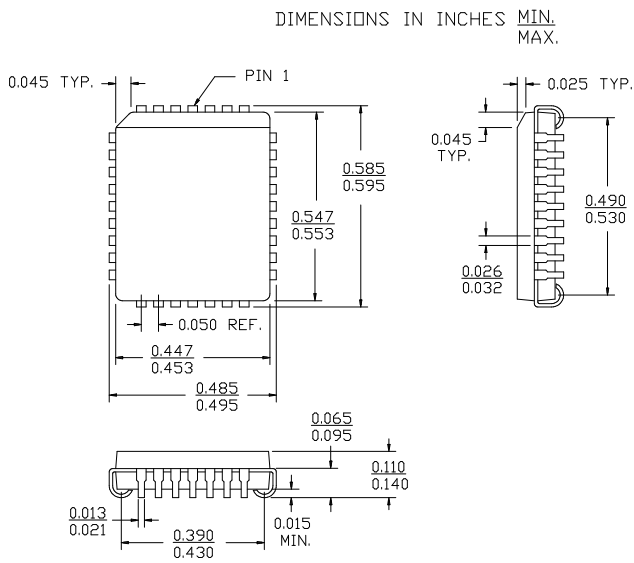

28-Lead (600-Mil) Molded DIP P15

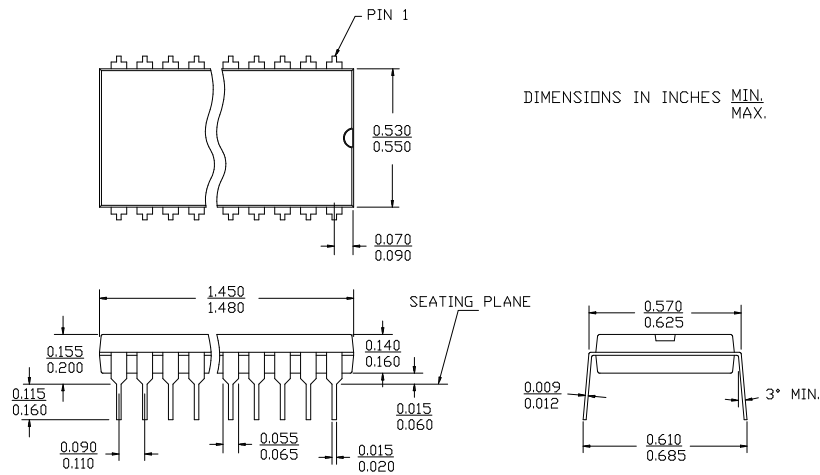

Package Diagrams (continued)

28-Lead (600-Mil) Windowed CerDIP W16
MIL-STD-1835 D-10 Config. A

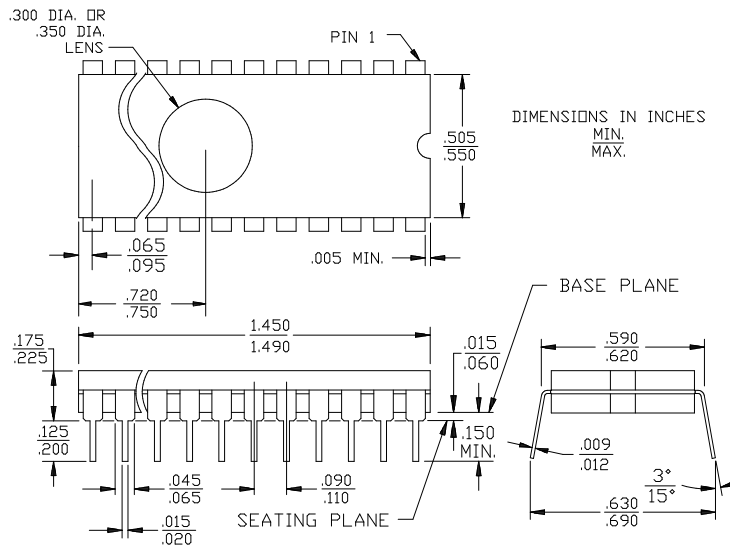

Copyright © Each Manufacturing Company.

All Datasheets cannot be modified without permission.

This datasheet has been download from :

www.AllDataSheet.com

100% Free DataSheet Search Site.

Free Download.

No Register.

Fast Search System.

www.AllDataSheet.com