



CMOS G65SC02-A 8-BIT MICROPROCESSOR

FEATURES

- CMOS family that is compatible with NMOS 6500 series microprocessors
- Uses single +5 volt power supply
- Low power consumption (4mA @ 1 MHz) allows battery-powered operation
- Enhanced instruction set: 27 additional op codes encompassing eight new instructions enhance software performance compared to existing NMOS 6500 microprocessor instruction set
 - 64 microprocessors instructions
 - 178 operational codes
 - 15 addressing modes
- 65K-byte addressable memory
- 1, 2, 3, 4, 5 or 6 MHz operation
- Choice of external or on-board clock generator operation
- On-board clock generator/oscillator can be driven by an external single-phase clock input, an RC network, or a crystal circuit
- Early address valid allows use with slower memories
- Early write data for dynamic memories
- 8-bit parallel processing
- Decimal binary arithmetic
- Pipeline architecture
- Programmable stack pointer
- Variable length stack
- Interrupt capability
- Non-maskable interrupt
- 8-bit bidirectional data bus
- "Ready" input (for single cycle execution)
- Direct memory access capability
- Bus compatible with M6800

GENERAL DESCRIPTION

The G65SCXX 8-bit microprocessor family is manufactured using the state-of-the-art silicon gate CMOS process. The G65SC02-A device is pin-to-pin compatible with NMOS versions of the 6500 currently on the market. The microprocessor is software compatible and provides 65K bytes of memory addressing and two interrupt inputs. It is bus compatible with MC6800 products.

As shown in Table I, the G65SC02-A clock generator circuit may be driven by an external crystal (Figure 2a), an RC network (Figure 2b) or by an external clock source. The G65SC02-A on-chip oscillator is intended for high performance, low cost operations where single phase inputs, crystals, or RC inputs provide the time base.

The microprocessor is pin-to-pin compatible with the NMOS 6500 microprocessors offered by several other manufacturers. However, the use of the leading-edge CMOS process technology ensures several software or programming enhancements not available to users of the NMOS 6500. The enhancements include two additional addressing modes, an expanded microprocessor instruction set (from 56 to 64 instructions), and expanded operational codes (from 151 to 178). In addition, a series of operational enhancements are provided which materially improve the effective use of the microprocessor. These enhancements are explained in Table V of the section of this data sheet devoted to system software and programming. This series of microprocessors provides the user an architecture and instruction set with which he is basically familiar (6502), the several operational enhancements notwithstanding, plus all of the advantages of leading edge CMOS technology; i.e., increased noise immunity, higher reliability, and greatly reduced power consumption.

In addition to enhanced software programming, the use of CMOS processing also allows several hardware enhancements that are not available to users of the NMOS 6500 products. These hardware enhancements are listed and explained in Table II.

The G65SC02-A microprocessor is available in plastic, ceramic, cerdip, or leadless chip carrier packaging. All versions are available in 1, 2, 3, 4, 5 and 6 MHz maximum operating frequencies.

Table 1. G65SC02-A Microprocessor Capabilities

Item No.	Part Number	DIP Pins	Addressable Memory (Bytes)	On-board Clock Oscillator (See Note)	External Clock Generator Required	Advanced Memory Access ($\phi 4$)	IRQ*	NMI*	SO*	DBE	BE	SYNC	RDY	ML*	RES*
1	G65SC02-A	40	65K	•			•	•	•			•	•		•

**Absolute Maximum Ratings: (See Note)**

Rating	Symbol	Value	Unit
Supply Voltage	V_{DD}	-0.3 to +7.0	V
Input Voltage	V_{IN}	-0.3 to $V_{DD} + 0.3$	V
Operating Temperature	T_A	-40 to +85	°C
Storage Temperature	T_S	-55 to +150	°C

This device contains input protection against damage due to high static voltages or electric fields; however, precautions should be taken to avoid application of voltages higher than the maximum rating. Note: Exceeding these ratings may result in permanent damage. Functional operation under these conditions is not implied.

DC Characteristics: $V_{DD} = 5.0V \pm 5\%$, $V_{SS} = 0V$, $T_A = -40^\circ\text{C}$ to $+85^\circ\text{C}$ Industrial, 0° to $+70^\circ\text{C}$ Commercial

Parameter	Symbol	Min	Max	Unit
Input High Voltage $\phi 0$ (IN), CLK (IN) RES*, NMI*, RDY, IRQ*, Data, SO*	V_{IH}	2.4 1.9	$V_{DD} + 0.3$ $V_{DD} + 0.3$	V V
Input Low Voltage $\phi 0$, (IN), CLK (IN) RES*, NMI*, RDY, IRQ*, Data, SO*	V_{IL}	-0.3 -0.3	0.4 0.9	V V
Input Leakage Current ($V_{IN} = 0$ to V_{DD}) RES*, NMI*, RDY, IRQ*, SO* $\phi 0$ (IN), CLK (IN) [02, 12, 112]	I_{IN}		1.0/-100 ± 1.0	μA μA
Three-State Leakage Current Address, Data, R/W*	I_{TSI}		± 10.0	μA
Output High Voltage ($I_{OH} = -100\mu\text{A}$, $V_{DD} = 4.75V$) SYNC, Data, A0-A15, R/W*	V_{OH}	2.4	-	V
Output Low Voltage ($I_{OL} = 1.6\text{mA}$, $V_{DD} = 4.5V$) SYNC, Data, A0-A15, R/W*	V_{OL}	-	0.4	V
Supply Current (No Load) $f = 1\text{ MHz}$ $f = 2\text{ MHz}$ $f = 3\text{ MHz}$ $f = 4\text{ MHz}$	I_{DD}	-	4 8 12 16	mA
Standby Power Dissipation (Inputs = V_{SS} or V_{DD} Outputs Unloaded)	P_{SBY}		50.0	μW
Capacitance ($V_{IN} = 0$, $T_A = 25^\circ\text{C}$, $f = 1\text{ MHz}$) Logic, $\phi 0$ (IN), CLK (IN) A0-A15, R/W* Data (Three-State)	C_{IN} C_{TS}	- -	10 15	pF



AC Characteristics: $V_{DD} = 5.0V \pm 5\%$, $T_A = -40^{\circ}C$ to $\pm 85^{\circ}C$ Industrial, $0^{\circ}C$ to $\pm 70^{\circ}C$ Commercial

Parameter	Symbol	1 MHz		2 MHz		3 MHz		4 MHz		5 MHz		6 MHz		Unit
		Min	Max	Min	Max	Min	Max	Min	Max	Min	Max	Min	Max	
Delay Time, $\phi 0$ (IN) to $\phi 2$ (OUT)	$t_{D\phi 0}$	—	40	—	40	—	40	—	40	—	35	—	30	ns
Delay Time, $\phi 2$ (IN) to $\phi 2$ (OUT)	$t_{D\phi 2}$	—	35	—	35	—	35	—	35	—	35	—	30	ns
Delay Time, $\phi 1$ (OUT) to $\phi 2$ (OUT)	$t_{D\phi 1}$	—	50	—	50	—	50	—	50	—	35	—	30	ns
Delay Time, $\phi 2$ (OUT) to $\overline{O\overline{S}C}$ (OUT)	t_{DOSC}	—	50	—	50	—	50	—	50	—	35	—	30	ns
Cycle Time	t_{CYC}	1.0	DC	0.50	DC	0.33	DC	0.25	DC	0.20	DC	0.167	DC	ns
Clock Pulse Width Low	$t_{PW}(\phi 2L)$	430	10000	210	10000	150	10000	100	10000	90	10000	80	10000	ns
Clock Pulse Width High	$t_{PW}(\phi 2H)$	450	—	220	—	160	—	110	—	85	—	75	—	ns
Fall Time, Rise Time	t_F, t_R	—	25	—	20	—	15	—	12	—	10	—	10	ns
Address Hold Time	t_{AH}	15	—	15	—	15	—	15	—	5	—	5	—	ns
Address Setup Time	t_{AS}	—	125	—	100	—	85	—	70	—	60	—	55	ns
Access Time	t_{ACC}	775	—	340	—	200	—	140	—	110	—	85	—	ns
Read Data Hold Time	t_{DHR}	10	—	10	—	10	—	10	—	5	—	5	—	ns
Read Data Setup Time	t_{DSR}	100	—	60	—	40	—	30	—	27	—	25	—	ns
Write Data Delay Time	t_{WDS}	—	175	—	100	—	75	—	55	—	50	—	45	ns
Write Data Hold Time	t_{DHW}	30	—	30	—	30	—	30	—	15	—	15	—	ns
SYNC, $\overline{M\overline{L}}$ Setup Time	$t_{SY, \overline{M\overline{L}}}$	—	125	—	100	—	85	—	70	—	60	—	55	ns
SYNC, $\overline{M\overline{L}}$ Hold Time	$t_{SYH, \overline{M\overline{L}}}$	10	—	10	—	10	—	10	—	5	—	5	—	ns
$\overline{S\overline{C}}$ Setup Time	t_{SC}	75	—	50	—	35	—	25	—	22	—	20	—	ns
Processor Control Setup Time	t_{PSC}	200	—	110	—	80	—	60	—	55	—	50	—	ns

Timing Diagram:

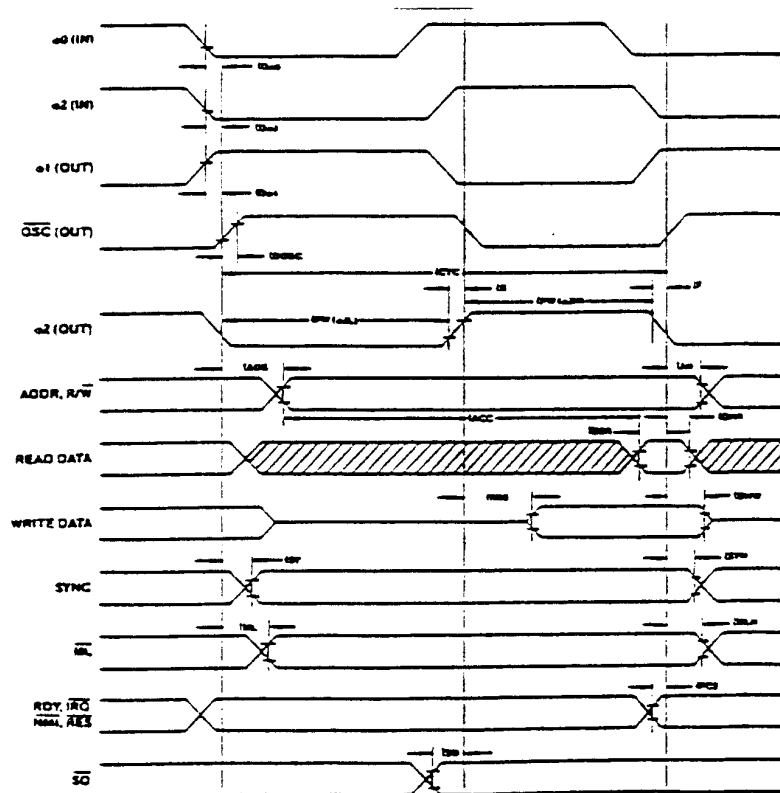

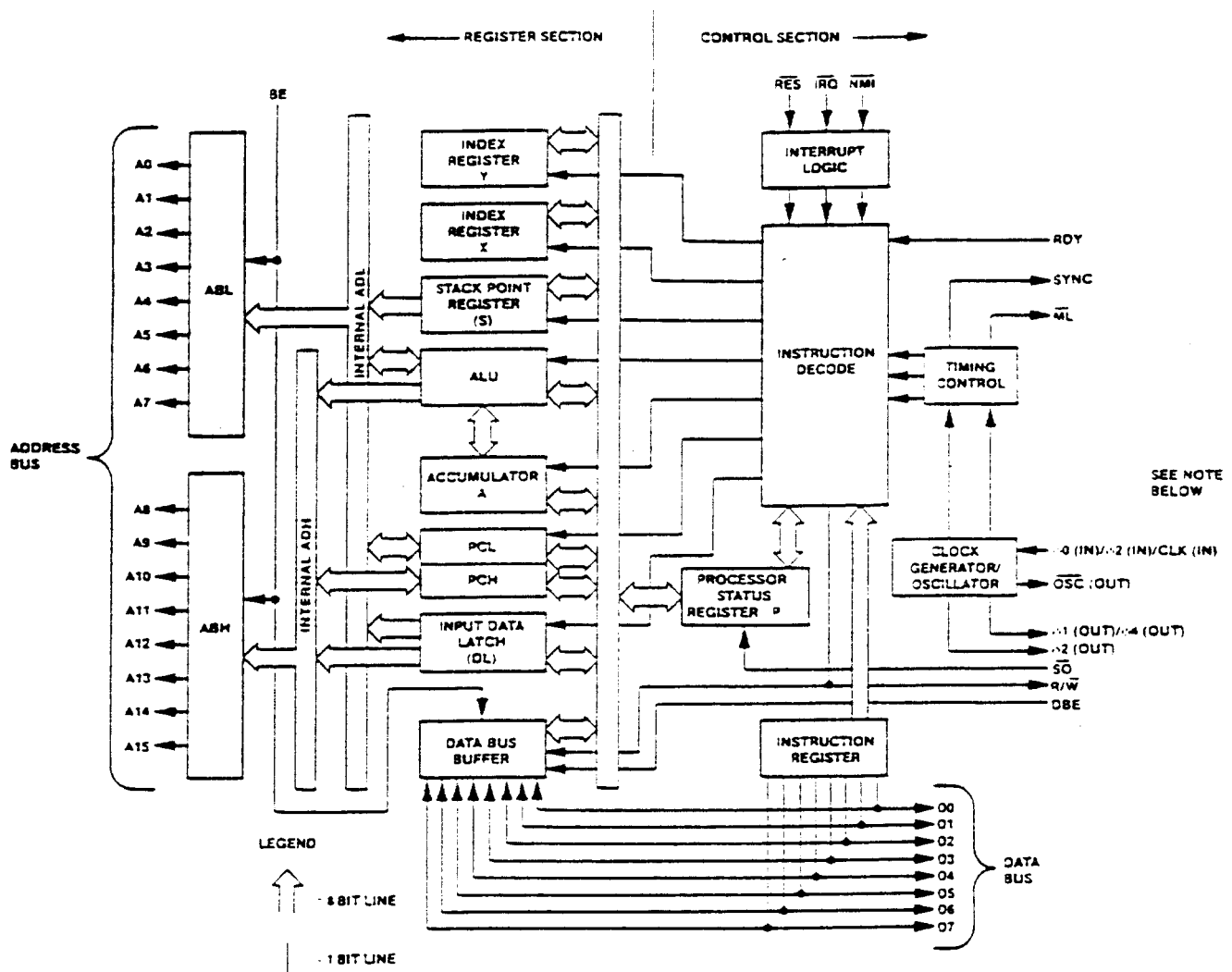

Note: Refer to Table I for signal input/output applicability.

Figure 1. Internal Architecture Simplified Block Diagram

FUNCTIONAL DESCRIPTION

Timing Control

The timing control unit keeps track of the instruction cycle being monitored. The unit is set to zero each time an instruction fetch is executed and is advanced at the beginning of each phase one clock pulse for as many cycles as is required to complete the instruction. Each data transfer which takes place between the registers depends upon decoding the contents of both the instruction register and the timing control unit.

Program Counter

The 16-bit program counter provides the addresses which step the microprocessor through sequential instructions in a program.

Each time the microprocessor fetches an instruction from program memory, the lower byte of the program counter (PCL) is placed on the low-order bits of the address bus and the higher byte of the program counter (PCH) is placed on the high-order 8 bits. The counter is incremented each time an instruction or data is fetched from program memory.

Instruction Register and Decode

Instructions fetched from memory are gated onto the internal data bus. These instructions are latched into the instruction register then decoded, along with timing and interrupt signals, to generate control signals for the various registers.

**Arithmetic and Logic Unit (ALU)**

All arithmetic and logic operations take place in the ALU including incrementing and decrementing internal registers (except the program counter). The ALU has no internal memory and is used only to perform logical and transient numerical operations.

Accumulator

The accumulator is a general purpose 8-bit register that stores the results of most arithmetic and logic operations. In addition, the accumulator usually contains one of the two data words used in these operations.

Index Registers

There are two 8-bit index registers (X and Y), which may be used to count program steps or to provide an index value to be used in generating an effective address.

When executing an instruction which specifies indexed addressing, the CPU fetches the op code and the base address,

and modifies the address by adding the index register to it prior to performing the desired operation. Pre- or post-indexing of indirect addresses is possible.

Stack Pointer

The stack pointer is an 8-bit register used to control the addressing of the variable-length stack. The stack pointer is automatically incremented and decremented under control of the microprocessor to perform stack manipulations under direction of either the program or interrupts (NMI* and IRQ*). The stack allows simple implementation of nested subroutines and multiple level interrupts.

Processor Status Register

The 8-bit processor status register contains seven status flags. Some of the flags are controlled by the program, others may be controlled both by the program and the CPU. The 6500 instruction set contains a number of conditional branch instructions which are designed to allow testing of these flags.

SIGNAL DESCRIPTION**Address Bus (A0-AXX)**

Refer to the particular package configuration for the respective number of address lines.

In both the 40-pin and 44-pin packages, A0-A15 forms a 16-bit address bus for memory and I/O exchanges on the data bus. The address lines are set (See BE below) to the high impedance state by the bus enable (BE) signal. The output of each address line is TTL compatible, capable of driving one standard TTL load and 130 pf.

Bus Enable (BE)

This signal allows external control of the data and the address output buffers and R/W*. For normal operation, BE is high causing the address buffers and R/W* to be active and the data buffers to be active during a write cycle. For external control, BE is held low to disable the buffers.

Phase 0 in ($\phi 0$ (IN))

This is the buffered clock input to the internal clock generator on the G65SC02-A series. Clock outputs $\phi 1$ (OUT) and $\phi 2$ (OUT) are derived from this signal.

Data Bus (D0-D7)

The data lines (D0-D7) constitute an 8-bit bidirectional data bus used for data exchanges to and from the device and peripherals. The outputs are three-state buffers capable of driving one TTL load and 103 pF.

Interrupt Request (IRQ*)

This TTL compatible signal requests that an interrupt sequence begin within the microprocessor. The IRQ* is sampled during $\phi 2$ operation. If the interrupt flag in the processor status register is zero, the current instruction is completed and the interrupt

sequence begins during $\phi 1$. The program counter and processor status register are stored in the stack. The microprocessor will then set the interrupt mask flag high so that no further interrupts may occur. At the end of this cycle, the program counter low will be loaded from address FFFE, and program counter high from location FFFF, transferring program control the memory vector located at these addresses. The RDY signal must be in the high state for any interrupt to be recognized. A 3K ohm external resistor should be used for proper wire-OR operation.

Non-Maskable Interrupt (NMI*)

A negative-going edge on this input requests that a non-maskable interrupt sequence be generated within the microprocessor. The NMI* is sampled during $\phi 2$; the current instruction is completed and the interrupt sequence begins during $\phi 1$. The program counter is loaded with the interrupt vector from locations FFFA (low byte) and FFFB (high byte), thereby transferring program control to the non-maskable interrupt routine. However, it should be noted this is an edge-sensitive input. As a result, another interrupt will occur if there is another negative-going transition and the program has not returned from a previous interrupt. Also, no interrupt will occur if NMI* is low and negative-going edge has not occurred since the last non-maskable interrupt.

Phase 1 Out ($\phi 1$ (OUT))

This inverted $\phi 2$ (OUT) signal provides timing for external R/W* operations.

Phase 2 Out ($\phi 2$ (OUT))

This signal provides timing for external bus R/W* operations. Addresses are valid after the address setup time (t_{ADS}) from the falling edge of $\phi 2$ (OUT).



SIGNAL DESCRIPTION (cont.)

Ready (RDY)

This input signal allows the user to single-cycle the microprocessor on all cycles including write cycles. A negative transition to the low state during or coincident with phase one ($\phi 1$) will halt the microprocessor with the output address lines reflecting the current address being fetched. This condition will remain through a subsequent phase two ($\phi 2$) in which the ready signal is low. This feature allows microprocessor interfacing with low-speed memory as well as direct memory access (DMA).

Reset (RES*)

This input is used to reset the microprocessor. Reset must be held low for at least two clock cycles after V_{DD} reaches operating voltage from a power down. A positive transition on this pin will then cause an initialization sequence to begin. After the system has been operating, a low on this line of at least two cycles will cease microprocessing activity.

When a positive edge is detected, there is an initialization sequence lasting six clock cycles. The previous program counter and status register values are written to the stack memory area. Then the interrupt mask flag is set, the decimal mode is cleared and the program counter is loaded with the restart vector from locations FFFC (low byte) and FFFD (high byte). This is the

start location for program control. This input should be high in normal operation.

Read/Write (R/W*)

This signal is normally in the high state indicating that the microprocessor is reading data from memory or I/O bus. In the low state the data bus has valid data from the microprocessor to be stored at the addressed memory location. R/W* is set to the high impedance state by BE.

Set Overflow (SO*)

A negative transition on this line sets the overflow bit in the status code register. The signal is sampled on the trailing edge of $\phi 1$.

Synchronize (SYNC)

This output line is provided to identify those cycles during which the microprocessor is doing an OP CODE fetch. The SYNC line goes high during $\phi 1$ of an OP CODE fetch and stays high for the remainder of that cycle. If the RDY line is pulled low during the $\phi 1$ clock awls in which SYNC went high, the processor will stop in its current state and will remain in the state until the RDY line goes high. In this manner, the SYNC signal can be used to control RDY to cause single instruction execution.

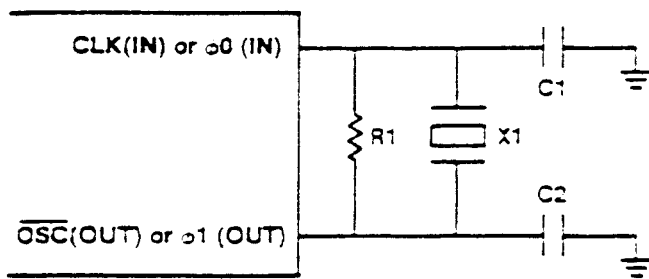

C1, C2 = 51pF
R1 = 200K Ω
X1 = 1MHz

Figure 2(a). Crystal Circuit for Internal Oscillator

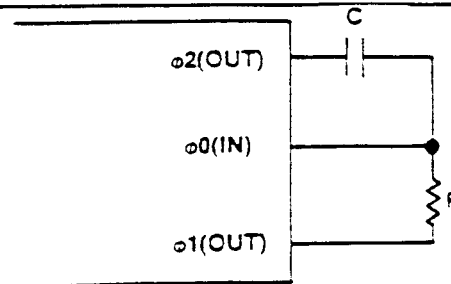

Suggested RC network configuration for internal oscillator.

1 MHz operation at $V_{DD} = 5.0V$:
C = 56pF
R = 5.6 K Ω

Figure 2(b). RC Circuit for Internal Oscillator

Table II. Microprocessor Hardware Enhancements

Function	NMOS 6500	G65SC02-A
Oscillator.	Requires external active components.	Crystal or RC network will oscillate when connected between $\phi 0$ (IN) and $\phi 1$ (OUT).
Assertion of Ready (RDY) during write operations.	Ignored.	Stops processor during $\phi 2$.
Unused input-only pins (IRQ*, NMI*, RDY, RES*, SO*, DBE, BE).	Must be connected to low impedance signal to avoid noise problems.	Connected internally by a high-resistance to V_{DD} (approximately 1 Megohm).

* Denotes inverted signal.



ADDRESSING MODES

Fifteen addressing modes are available to the user of the CMD G65SC02-A family of microprocessors. The addressing modes are described in the following paragraphs:

Implied Addressing

In the implied addressing mode, the address containing the operand is implicitly stated in the operation code of the instruction.

Accumulator Addressing

This form of addressing is represented with a one byte instruction and implies an operation of the accumulator.

Immediate Addressing

With immediate addressing, the operand is contained in the second byte of the instruction; no further memory addressing is required.

Absolute Addressing

For absolute addressing, the second byte of the instruction specifies the eight low order bits of the effective address while the third byte specifies the eight high order bits. Therefore, this addressing mode allows access to the total 65K bytes of addressable memory.

Zero Page Addressing

Zero page addressing allows shorter code and execution times by only fetching the second byte of the instruction and assuming a zero high address byte. The careful use of zero page addressing can result in significant increase in code efficiency.

Absolute Indexed Addressing

Absolute indexed addressing is used in conjunction with X and Y index register and is referred to as "Absolute.X." and "Absolute.Y." The effective address is formed by adding the contents of X and Y to the address contained in the second and third bytes of the instruction. This mode allows the index register to contain the index or count value and the instruction to contain the base address. This type of indexing allows any location referencing and the index to modify multiple fields resulting in reduced coding and execution time.

Zero Page Indexed Addressing

Zero page absolute addressing is used in conjunction with the index register and is referred to as "Zero Page.X" or "Zero Page.Y." The effective address is calculated by adding the second byte to the contents of the index register. Since this is a form of "Zero Page" addressing, the content of the second byte references a location in page zero. Additionally, due to the "Zero Page" addressing nature of this mode, no carry is added to the high order eight bits of memory and crossing of page boundaries does not occur.

boundaries does not occur.

Relative Addressing

Relative addressing is used only with branch instruction; it establishes a destination for the conditional branch.

Zero Page Indexed Indirect Addressing

With zero page indexed indirect addressing (usually referred to as indirect X) the second byte of the instruction is added to the contents of the X index register; the carry is discarded. The result of this addition points to a memory location on page zero whose contents is the low order eight bits of the effective address. The next memory location in page zero contains the high order eight bits of the effective address. Both memory locations specifying the high and low order bytes of the effective address must be in page zero.

Absolute Indexed Indirect Addressing (Jump Instruction Only)

With absolute indexed indirect addressing, the contents of the second and third instruction bytes are added to the X register. The result of this addition points to a memory location containing the lower-order eight bits of the effective address. The next memory location contains the higher-order eight bits of the effective address.

Indirect Indexed Addressing

This form of addressing is usually referred to as Indirect.Y. The second byte of the instruction points to a memory location in page zero. The contents of this memory location is added to the contents of the Y index register, the result being the low order eight bits of the effective address. The carry from this addition is added to the contents of the next page zero memory location, the result being the high order eight bits of the effective address.

Zero Page Indirect Addressing

In this form of addressing, the second byte of the instruction contains the low order eight bits of a memory location. The high order eight bits is always zero. The contents of the fully specified memory location is the low order byte of the effective address. The next memory location contains the high order byte of the effective address.

Absolute Indirect Addressing (Jump Instruction Only)

The second byte of the instruction contains the low order eight bits of a memory location. The high order eight bits of that memory location is contained in the third byte of the instruction. The contents of the fully specified memory location is the low order byte of the effective address. The next memory location contains the high order byte of the effective address which is loaded into the 16 bits of the program counter.

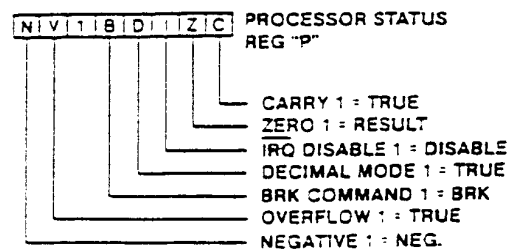
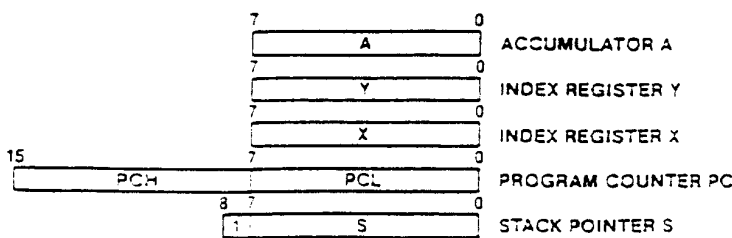

Figure 3. Microprocessor Programming Model

* Denotes inverted signal.



Table III. Instruction Set—Alphabetical Sequence

AOC	Add Memory to Accumulator with Carry	LDY	Load Index Y with Memory
AND	"AND" Memory with Accumulator	LSR	Shift One Bit Right
ASL	Shift One Bit Left	NOP	No Operation
BCC	Branch on Carry Clear	ORA	"OR" Memory with Accumulator
BCS	Branch on Carry Set	PHA	Push Accumulator on Stack
BEQ	Branch on Result Zero	PHP	Push Processor Status on Stack
BIT	Test Memory Bits with Accumulator	• PHX	Push Index X on Stack
BMI	Branch on Result Minus	• PHY	Push Index Y on Stack
BNE	Branch on Result Not Zero	PLA	Pop Accumulator from Stack
BPL	Branch on Result Plus	PLP	Pop Processor Status from Stack
• BRA	Branch Always	• PLX	Pop Index X from Stack
BRK	Force Break	• PLY	Pop Index Y from Stack
BVC	Branch on Overflow Clear	RCL	Rotate One Bit Left
BVS	Branch on Overflow Set	ROR	Rotate One Bit Right
CLC	Clear Carry Flag	RTI	Return from Interrupt
CLD	Clear Decimal Mode	RTS	Return from Subroutine
CLI	Clear Interrupt Disable Bit	SBC	Subtract Memory from Accumulator with Borrow
CLV	Clear Overflow Flag	SEC	Set Carry Flag
CMP	Compare Memory and Accumulator	SED	Set Decimal Mode
CPX	Compare Memory and Index X	SEI	Set Interrupt Disable Bit
CPY	Compare Memory and Index Y	STA	Store Accumulator in Memory
DEC	Decrement by One	STX	Store Index X in Memory
DEX	Decrement Index X by One	STY	Store Index Y in Memory
DEY	Decrement Index Y by One	• STZ	Store Zero in Memory
EOR	"Exclusive-OR" Memory with Accumulator	TAX	Transfer Accumulator to Index X
INC	Increment by One	TAY	Transfer Accumulator to Index Y
INX	Increment Index X by One	• TRB	Test and Reset Memory Bits with Accumulator
INY	Increment Index Y by One	• TSB	Test and Set Memory Bits with Accumulator
JMP	Jump to New Location	TSX	Transfer Stack Pointer to Index X
JSR	Jump to New Location Saving Return Address	TXA	Transfer Index X to Accumulator
LDA	Load Accumulator with Memory	TXS	Transfer Index X to Stack Pointer
LDX	Load Index X with Memory	TYA	Transfer Index Y to Accumulator

Note: • = New Instruction

Op Code	0	1	2	3	4	5	6	7	8	9	A	B	C	D	E	F
0	BRK ind. X	ORA ind. Y			SBC ind. X	ORA zdg. X	ASL zdg.	PHP	ORA imm	ASL A			ORA zds.	ASL zds.		0
1	BPL rel	ORA ind. Y			SBC zdg. X	ORA zdg. X	ASL zdg. X	CLC	ORA zds. Y				ORA zds. X	ASL zds. X		1
2	JSR zds.	AND ind. X			BIT zdg.	AND zdg.	RCL zdg.	PLP	AND imm	RCL A			BIT zds.	AND zds.	RCL zds.	2
3	BMI rel	AND ind. Y			SBC zdg. X	AND zdg. X	RCL zdg. X	SEC	AND zds. Y				AND zds. X	RCL zds. X		3
4	RTI	EOR ind. X			EOR zdg.	LSR zdg.		PHA	EOR imm	LSR A			JMP zds.	EOR zds.	LSR zds.	4
5	BVC rel	EOR ind. Y			EOR zdg. X	LSR zdg. X		CLI	EOR zds. Y				EOR zds. X	LSR zds. X		5
6	RTS	ADC ind. X			SBC zdg.	ADC zdg.	ROR zdg.	PLA	ADC imm	ROR A			JMP ind.	ADC zds.	ROR zds.	6
7	BVS rel	ADC ind. Y			SBC zdg. X	ADC zdg. X	ROR zdg. X	SEI	ADC zds. Y				ADC zds. X	ROR zds. X		7
8	BRA rel	STA ind. X			STY zdg.	STA zdg.	STX zdg.	DEY		TXA			STY zds.	STA zds.	STX zds.	8
9	BCC rel	STA ind. Y			STY zdg. X	STA zdg. X	STX zdg. Y	TYA	STA zds. Y	TXS			STA zds. X			9
A	LDY imm	LDA ind. X	LDM imm		LDY zdg.	LDA zdg.	LDM zdg.	TAY	LDA imm	TAX			LDY zds.	LDA zds.	LDM zds.	A
B	BCS rel	LDA ind. Y			LDY zdg. X	LDA zdg. X	LDM zdg. Y	CLV	LDA zds. Y	TSX			LDY zds. X	LDA zds. X	LDM zds. Y	B
C	CPY imm	CMP ind. X			CPY zdg.	CMP zdg.	DEC zdg.	INY	CMP imm	DEX			CPY zds.	CMP zds.	DEC zds.	C
D	BNE rel	CMP ind. Y			CMP zdg. X	DEC zdg. X		CLD	CMP zds. Y				CMP zds. X	DEC zds. X		D
E	CPX imm	SBC ind. X			CPX zdg.	SBC zdg.	INC zdg.	INX	SBC imm	NOP			CPX zds.	SBC zds.	INC zds.	E
F	BEQ rel	SBC ind. Y			SBC zdg. X	INC zdg. X		SED	SBC zds. Y				SBC zds. X	INC zds. X		F

Note: □ = New Op Codes

Figure 4. Microprocessor Op Code Table

• Denotes inverted signal.



Enhanced Operational Characteristics

The CMD G65SC02-A microprocessor is designed for building state-of-the-art microcomputer systems. The device utilizes the same basic software instruction set, and to be bus compatible with the MC6800 product line. Accordingly, the G65SC02-A series is pin compatible with existing NMOS 6500 type microprocessors.

However, as stated previously, the CMOS design allows several operational enhancements to be incorporated in the current product. These operational enhancements are explained in Table V.

Table V. Microprocessor Operational Enhancements

Function	NMOS 6500 Microprocessor	G65SC02-A Microprocessor																					
Indexed addressing across the page boundary.	Extra read of invalid address.	Extra read of last instruction byte.																					
Execution of invalid op codes.	Some terminate only by reset. Results are undefined.	All are NOPs (reserved for future use). <table border="1" style="margin-left: 20px;"> <thead> <tr> <th>Op Code</th> <th>Bytes</th> <th>Cycles</th> </tr> </thead> <tbody> <tr> <td>X2</td> <td>2</td> <td>2</td> </tr> <tr> <td>X3, X7, XB, XF</td> <td>1</td> <td>1</td> </tr> <tr> <td>44</td> <td>2</td> <td>3</td> </tr> <tr> <td>54, D4, F4</td> <td>2</td> <td>4</td> </tr> <tr> <td>5C</td> <td>3</td> <td>8</td> </tr> <tr> <td>DC, FC</td> <td>3</td> <td>4</td> </tr> </tbody> </table>	Op Code	Bytes	Cycles	X2	2	2	X3, X7, XB, XF	1	1	44	2	3	54, D4, F4	2	4	5C	3	8	DC, FC	3	4
Op Code	Bytes	Cycles																					
X2	2	2																					
X3, X7, XB, XF	1	1																					
44	2	3																					
54, D4, F4	2	4																					
5C	3	8																					
DC, FC	3	4																					
Jump indirect, operand = XXFF.	Page address does not increment.	Page address increments, one additional cycle.																					
Read/modify/write instructions at effective address.	One read and two write cycles.	Two read and one write cycle.																					
Decimal flag.	Indeterminate after reset.	Initialized to binary mode (D=0) after reset and interrupts.																					
Flags after decimal operation.	Invalid N, V and Z flags.	Valid flags. One additional cycle.																					
Interrupt after fetch of BRK instruction.	Interrupt vector is loaded; BRK vector is ignored.	BRK is executed, then interrupt is executed.																					
Reset.	Reads three stack locations.	Writes program counter and status register to stack.																					
Read/Modify/Write instructions absolute indexed in same page.	Seven cycles.	Six cycles																					

Pin Function

Pin	Description
A0-Axx	Address Bus
$\phi 0$ (IN)	Phase 0 In
D0-D7	Data Bus
IRQ*	Interrupt Request
NC	No Connection
NMI*	Non-Maskable Interrupt

Pin	Description
$\phi 1$ (OUT)	Phase 1 Out
$\phi 2$ (OUT)	Phase 2 Out
RDY	Ready
RES*	Reset
R/W*	Read/Write
SO*	Set Overflow
SYNC	Synchronize
V _{DD}	Positive Power Supply (+5.0 Volts)
V _{SS}	Internal Logic Ground

* Denotes inverted signal.



Pin Configuration

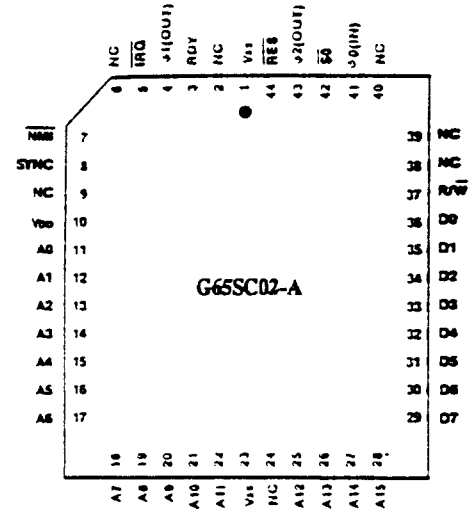
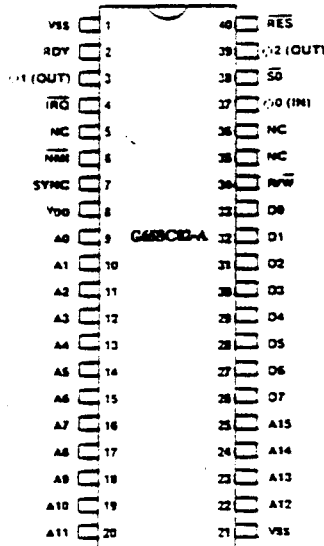

Ordering Information

